

Trauma

Product Catalog

TRAUMA

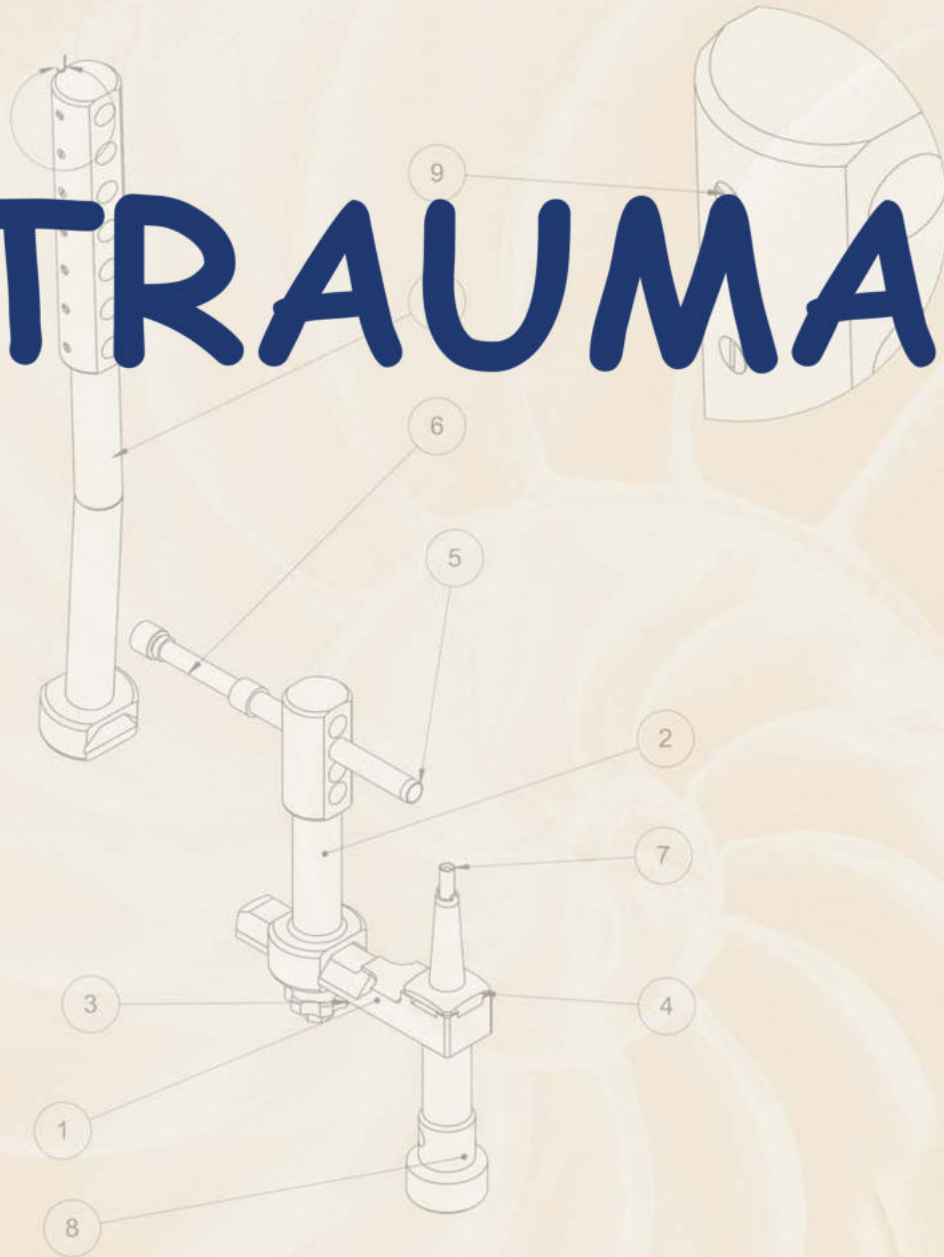

Biotech GmbH
Hauptstraße 113.
56598 Rheinbrohl Germany
Tel : +49 2635 92221-0
Email : office-de@biotech-medical.net
www.biotech-medical.com



BIOTECH

REF:
VB-006-PROSP-PC

Revision
2

Publication date :
01.04.2022.

"Movement is Life"



BIOTECH TRAUMA

I. Screws

II. Plates

III. Pins, wires, staples

IV. Femoral neck screw fixation

V. Dynamic screw fixation

VI. Intra-medullary Nails

VII. External Fixation

I. Screws

1. Cortical screws
2. Cortical screws with self-tapping thread
3. Cannulated cortical screws
4. Malleolar screw
5. Cannulated malleolar screw
6. Cancellous screws
7. Cannulated screws
8. Locking bone screws
9. pertrochanter screws
10. Interference screws
11. Locking screws for angle stabilised plates
12. schans screws

UNIVERSAL SCREWS, NUTS, WASHERS

Cortical bone screw

d=1,5 mm		
L mm	TITAN	STEEL
5	902-202-15005	902-302-15005
6	902-202-15006	902-302-15006
7	902-202-15007	902-302-15007
8	902-202-15008	902-302-15008
9	902-202-15009	902-302-15009
10	902-202-15010	902-302-15010
11	902-202-15011	902-302-15011
12	902-202-15012	902-302-15012
13	902-202-15013	902-302-15013
14	902-202-15014	902-302-15014
15	902-202-15015	902-302-15015
16	902-202-15016	902-302-15016
17	902-202-15017	902-302-15017
18	902-202-15018	902-302-15018
19	902-202-15019	902-302-15019
20	902-202-15020	902-302-15020
21	902-202-15021	902-302-15021
22	902-202-15022	902-302-15022

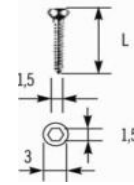

d=2,0 mm		
L mm	TITAN	STEEL
6	902-202-20006	902-302-20006
8	902-202-20008	902-302-20008
10	902-202-20010	902-302-20010
11	902-202-20011	902-302-20011
12	902-202-20012	902-302-20012
13	902-202-20013	902-302-20013
14	902-202-20014	902-302-20014
16	902-202-20016	902-302-20016
18	902-202-20018	902-302-20018
20	902-202-20020	902-302-20020
22	902-202-20022	902-302-20022
24	902-202-20024	902-302-20024
26	902-202-20026	902-302-20026
28	902-202-20028	902-302-20028
30	902-202-20030	902-302-20030
32	902-202-20032	902-302-20032
34	902-202-20034	902-302-20034
36	902-202-20036	902-302-20036
38	902-202-20038	902-302-20038
40	902-202-20040	902-302-20040

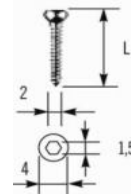

UNIVERSAL SCREWS, NUTS, WASHERS

Cortical bone screw, selftapping

d=1,5 mm		
L mm	TITAN	STEEL
5	905-205-15005	905-305-15005
6	905-205-15006	905-305-15006
7	905-205-15007	905-305-15007
8	905-205-15008	905-305-15008
9	905-205-15009	905-305-15009
10	905-205-15010	905-305-15010
11	905-205-15011	905-305-15011
12	905-205-15012	905-305-15012
13	905-205-15013	905-305-15013
14	905-205-15014	905-305-15014
15	905-205-15015	905-305-15015
16	905-205-15016	905-305-15016
17	905-205-15017	905-305-15017
18	905-205-15018	905-305-15018
19	905-205-15019	905-305-15019
20	905-205-15020	905-305-15020
21	905-205-15021	905-305-15021
22	905-205-15022	905-305-15022

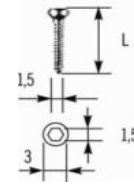

d=2,0 mm		
L mm	TITAN	STEEL
6	905-205-20006	905-305-20006
8	905-205-20008	905-305-20008
10	905-205-20010	905-305-20010
11	905-205-20011	905-305-20011
12	905-205-20012	905-305-20012
13	905-205-20013	905-305-20013
14	905-205-20014	905-305-20014
16	905-205-20016	905-305-20016
18	905-205-20018	905-305-20018
20	905-205-20020	905-305-20020
22	905-205-20022	905-305-20022
24	905-205-20024	905-305-20024
26	905-205-20026	905-305-20026
28	905-205-20028	905-305-20028
30	905-205-20030	905-305-20030
32	905-205-20032	905-305-20032
34	905-205-20034	905-305-20034
36	905-205-20036	905-305-20036
38	905-205-20038	905-305-20038
40	905-205-20040	905-305-20040

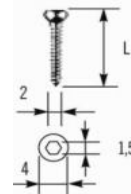

Cortical bone screw

d=2,7 mm		
L mm	TITAN	STEEL
6	902-202-27006	902-302-27006
8	902-202-27008	902-302-27008
10	902-202-27010	902-302-27010
12	902-202-27012	902-302-27012
14	902-202-27014	902-302-27014
16	902-202-27016	902-302-27016
18	902-202-27018	902-302-27018
20	902-202-27020	902-302-27020
22	902-202-27022	902-302-27022
24	902-202-27024	902-302-27024
26	902-202-27026	902-302-27026
28	902-202-27028	902-302-27028
30	902-202-27030	902-302-27030
32	902-202-27032	902-302-27032
34	902-202-27034	902-302-27034
36	902-202-27036	902-302-27036
38	902-202-27038	902-302-27038
Core hole for screw head:		
	d = 2 mm	

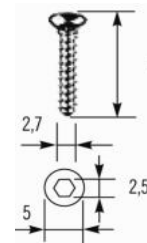

Cortical bone screw

3,5/1,75 mm D=5 mm		
L mm	TITAN	STEEL
8	903-203-35008	903-303-35008
10	903-203-35010	903-303-35010
12	903-203-35012	903-303-35012
14	903-203-35014	903-303-35014
16	903-203-35016	903-303-35016
18	903-203-35018	903-303-35018
20	903-203-35020	903-303-35020
Core hole for screw thread:		
d = 2,5 mm		

3,5/1,75 mm D=6 mm		
L mm	TITAN	STEEL
8	902-202-35008	902-302-35008
10	902-202-35010	902-302-35010
12	902-202-35012	902-302-35012
14	902-202-35014	902-302-35014
16	902-202-35016	902-302-35016
18	902-202-35018	902-302-35018
20	902-202-35020	902-302-35020
22	902-202-35022	902-302-35022
24	902-202-35024	902-302-35024
26	902-202-35026	902-302-35026
28	902-202-35028	902-302-35028
32	902-202-35032	902-302-35032
36	902-202-35036	902-302-35036
40	902-202-35040	902-302-35040
45	902-202-35045	902-302-35045
50	902-202-35050	902-302-35050
55	902-202-35055	902-302-35055
60	902-202-35060	902-302-35060
65	902-202-35065	902-302-35065
70	902-202-35070	902-302-35070
Core hole for screw thread:		
d = 2,5 mm		

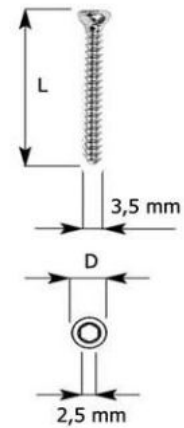

Cortical bone screw

d=3,5 mm		
L mm	TITAN	STEEL
8	904-204-35008	904-304-35008
10	904-204-35010	904-304-35010
12	904-204-35012	904-304-35012
14	904-204-35014	904-304-35014
16	904-204-35016	904-304-35016
18	904-204-35018	904-304-35018
20	904-204-35020	904-304-35020
22	904-204-35022	904-304-35022
24	904-204-35024	904-304-35024
26	904-204-35026	904-304-35026
28	904-204-35028	904-304-35028
30	904-204-35030	904-304-35030
32	904-204-35032	904-304-35032
34	904-204-35034	904-304-35034
36	904-204-35036	904-304-35036
38	904-204-35038	904-304-35038
40	904-204-35040	904-304-35040
42	904-204-35042	904-304-35042
44	904-204-35044	904-304-35044
46	904-204-35046	904-304-35046
48	904-204-35048	904-304-35048
50	904-204-35050	904-304-35050
52	904-204-35052	904-304-35052
54	904-204-35054	904-304-35054
56	904-204-35056	904-304-35056
58	904-204-35058	904-304-35058
60	904-204-35060	904-304-35060
62	904-204-35062	904-304-35062
64	904-204-35064	904-304-35064
66	904-204-35066	904-304-35066
68	904-204-35068	904-304-35068
70	904-204-35070	904-304-35070
72	904-204-35072	904-304-35072
74	904-204-35074	904-304-35074
76	904-204-35076	904-304-35076
78	904-204-35078	904-304-35078
80	904-204-35080	904-304-35080
85	904-204-35085	904-304-35085
90	904-204-35090	904-304-35090
95	904-204-35095	904-304-35095
100	904-204-35100	904-304-35100
105	904-204-35105	904-304-35105
110	904-204-35110	904-304-35110
115	904-204-35115	904-304-35115
120	904-204-35120	904-304-35120
125	904-204-35125	904-304-35125
130	904-204-35130	904-304-35130

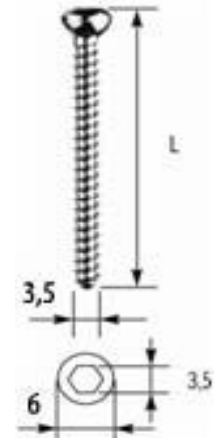

Cortical bone screw

4,5 mm		
L mm	TITAN	STEEL
12	902-202-45012	902-302-45012
14	902-202-45014	902-302-45014
16	902-202-45016	902-302-45016
18	902-202-45018	902-302-45018
20	902-202-45020	902-302-45020
22	902-202-45022	902-302-45022
24	902-202-45024	902-302-45024
26	902-202-45026	902-302-45026
28	902-202-45028	902-302-45028
30	902-202-45030	902-302-45030
32	902-202-45032	902-302-45032
34	902-202-45034	902-302-45034
36	902-202-45036	902-302-45036
38	902-202-45038	902-302-45038
40	902-202-45040	902-302-45040
42	902-202-45042	902-302-45042
44	902-202-45044	902-302-45044
46	902-202-45046	902-302-45046
48	902-202-45048	902-302-45048
50	902-202-45050	902-302-45050
52	902-202-45052	902-302-45052
54	902-202-45054	902-302-45054
56	902-202-45056	902-302-45056
58	902-202-45058	902-302-45058
60	902-202-45060	902-302-45060
62	902-202-45062	902-302-45062
64	902-202-45064	902-302-45064
66	902-202-45066	902-302-45066
68	902-202-45068	902-302-45068
70	902-202-45070	902-302-45070
72	902-202-45072	902-302-45072
74	902-202-45074	902-302-45074
76	902-202-45076	902-302-45076
78	902-202-45078	902-302-45078
80	902-202-45080	902-302-45080
85	902-202-45085	902-302-45085
90	902-202-45090	902-302-45090
95	902-202-45095	902-302-45095
100	902-202-45100	902-302-45100
105	902-202-45105	902-302-45105
110	902-202-45110	902-302-45110
115	902-202-45115	902-302-45115
120	902-202-45120	902-302-45120
125	902-202-45125	902-302-45125
130	902-202-45130	902-302-45130
135	902-202-45135	902-302-45135
140	902-202-45140	902-302-45140

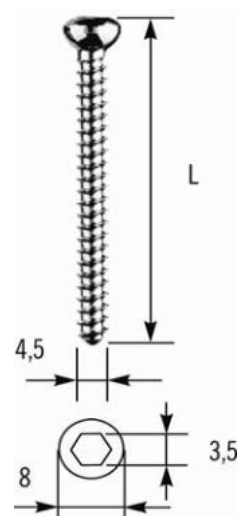

UNIVERSAL SCREWS, NUTS, WASHERS

Cannulated cortical bone screw

d=3,5 mm		
L mm	TITAN	STEEL
10	907-207-35010	907-307-35010
12	907-207-35012	907-307-35012
14	907-207-35014	907-307-35014
16	907-207-35016	907-307-35016
18	907-207-35018	907-307-35018
20	907-207-35020	907-307-35020
22	907-207-35022	907-307-35022
24	907-207-35024	907-307-35024
26	907-207-35026	907-307-35026
28	907-207-35028	907-307-35028
30	907-207-35030	907-307-35030
32	907-207-35032	907-307-35032
34	907-207-35034	907-307-35034
36	907-207-35036	907-307-35036
38	907-207-35038	907-307-35038
40	907-207-35040	907-307-35040
42	907-207-35042	907-307-35042
44	907-207-35044	907-307-35044
46	907-207-35046	907-307-35046
48	907-207-35048	907-307-35048
50	907-207-35050	907-307-35050
52	907-207-35052	907-307-35052
54	907-207-35054	907-307-35054
56	907-207-35056	907-307-35056
58	907-207-35058	907-307-35058
60	907-207-35060	907-307-35060
65	907-207-35065	907-307-35065
70	907-207-35070	907-307-35070

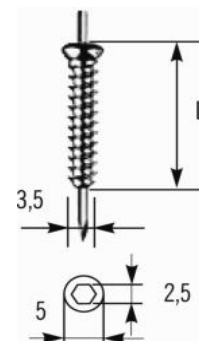

UNIVERSAL SCREWS, NUTS, WASHERS

Cannulated cortical bone screw

d= 4,5 mm		
L mm	TITAN	STEEL
10	907-207-45010	907-307-45010
12	907-207-45012	907-307-45012
14	907-207-45014	907-307-45014
16	907-207-45016	907-307-45016
18	907-207-45018	907-307-45018
20	907-207-45020	907-307-45020
22	907-207-45022	907-307-45022
24	907-207-45024	907-307-45024
26	907-207-45026	907-307-45026
28	907-207-45028	907-307-45028
30	907-207-45030	907-307-45030
32	907-207-45032	907-307-45032
34	907-207-45034	907-307-45034
36	907-207-45036	907-307-45036
38	907-207-45038	907-307-45038
40	907-207-45040	907-307-45040
42	907-207-45042	907-307-45042
44	907-207-45044	907-307-45044
46	907-207-45046	907-307-45046
48	907-207-45048	907-307-45048
50	907-207-45050	907-307-45050
52	907-207-45052	907-307-45052
54	907-207-45054	907-307-45054
56	907-207-45056	907-307-45056
58	907-207-45058	907-307-45058
60	907-207-45060	907-307-45060
65	907-207-45065	907-307-45065
70	907-207-45070	907-307-45070

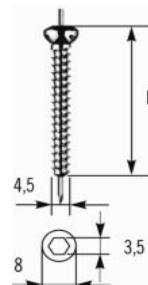

UNIVERSAL SCREWS, NUTS, WASHERS

Malleolar bone screw

L mm	b mm	TITAN	STEEL
20	10	906-206-00020	906-306-00020
25	12,5	906-206-00025	906-306-00025
30	15	906-206-00030	906-306-00030
35	17,5	906-206-00035	906-306-00035
40	20	906-206-00040	906-306-00040
45	22,5	906-206-00045	906-306-00045
50	25	906-206-00050	906-306-00050
55	27,5	906-206-00055	906-306-00055
60	30	906-206-00060	906-306-00060
65	32,5	906-206-00065	906-306-00065
70	35	906-206-00070	906-306-00070
75	37,5	906-206-00075	906-306-00075
80	40	906-206-00080	906-306-00080

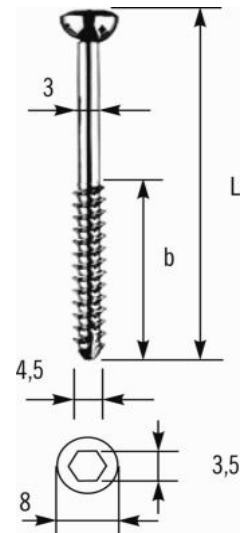

Cannulated malleolar bone screw

L mm	b mm	TITAN	STEEL
25	12,5	909-209-25012	909-309-25012
30	15	909-209-25015	909-309-25015
35	17,5	909-209-25017	909-309-25017
40	20	909-209-25020	909-309-25020
45	22,5	909-209-25022	909-309-25022
50	25	909-209-25025	909-309-25025
55	27,5	909-209-25027	909-309-25027
60	30	909-209-25030	909-309-25030
65	32,5	909-209-25032	909-309-25032
70	35	909-209-00035	909-309-00035

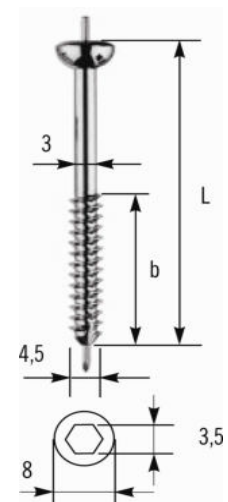

UNIVERSAL SCREWS, NUTS, WASHERS

cancellous bone screw, half threaded

d=3,5 mm		
L mm	TITAN	STEEL
8	926-226-35008	926-326-35008
10	926-226-35010	926-326-35010
12	926-226-35012	926-326-35012
14	926-226-35014	926-326-35014
16	926-226-35016	926-326-35016
18	926-226-35018	926-326-35018
20	926-226-35020	926-326-35020
22	926-226-35022	926-326-35022
24	926-226-35024	926-326-35024
26	926-226-35026	926-326-35026
28	926-226-35028	926-326-35028
30	926-226-35030	926-326-35030
32	926-226-35032	926-326-35032
34	926-226-35034	926-326-35034
36	926-226-35036	926-326-35036
38	926-226-35038	926-326-35038
40	926-226-35040	926-326-35040
42	926-226-35042	926-326-35042
44	926-226-35044	926-326-35044
46	926-226-35046	926-326-35046
48	926-226-35048	926-326-35048
50	926-226-35050	926-326-35050
55	926-226-35055	926-326-35055
60	926-226-35060	926-326-35060

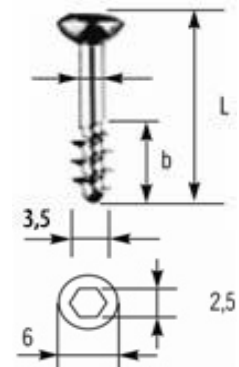

UNIVERSAL SCREWS, NUTS, WASHERS

cancellous bone screw, fully threaded

d=3,5 mm		
L mm	TITAN	STEEL
8	911-211-35008	911-311-35008
10	911-211-35010	911-311-35010
12	911-211-35012	911-311-35012
14	911-211-35014	911-311-35014
16	911-211-35016	911-311-35016
18	911-211-35018	911-311-35018
20	911-211-35020	911-311-35020
22	911-211-35022	911-311-35022
24	911-211-35024	911-311-35024
26	911-211-35026	911-311-35026
28	911-211-35028	911-311-35028
30	911-211-35030	911-311-35030
32	911-211-35032	911-311-35032
34	911-211-35034	911-311-35034
36	911-211-35036	911-311-35036
38	911-211-35038	911-311-35038
40	911-211-35040	911-311-35040
42	911-211-35042	911-311-35042
44	911-211-35044	911-311-35044
46	911-211-35046	911-311-35046
48	911-211-35048	911-311-35048
50	911-211-35050	911-311-35050
55	911-211-35055	911-311-35055
60	911-211-35060	911-311-35060

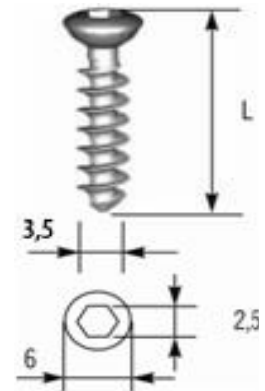

Cancellous bone screw

d=4,5mm, fully threaded		
L mm	TITAN	STEEL
10	911-211-45010	911-311-45010
12	911-211-45012	911-311-45012
14	911-211-45014	911-311-45014
16	911-211-45016	911-311-45016
18	911-211-45018	911-311-45018
20	911-211-45020	911-311-45020
22	911-211-45022	911-311-45022
24	911-211-45024	911-311-45024
26	911-211-45026	911-311-45026
28	911-211-45028	911-311-45028
30	911-211-45030	911-311-45030
32	911-211-45032	911-311-45032
34	911-211-45034	911-311-45034
36	911-211-45036	911-311-45036
38	911-211-45038	911-311-45038
40	911-211-45040	911-311-45040
42	911-211-45042	911-311-45042
44	911-211-45044	911-311-45044
46	911-211-45046	911-311-45046
48	911-211-45048	911-311-45048
50	911-211-45050	911-311-45050
55	911-211-45055	911-311-45055
60	911-211-45060	911-311-45060

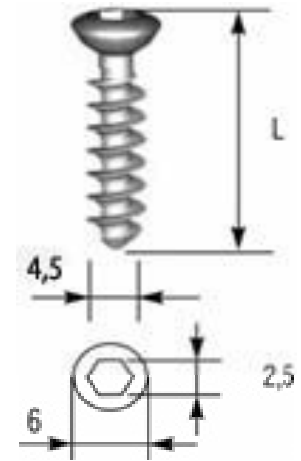

UNIVERSAL SCREWS, NUTS, WASHERS

Cancellous bone screw

d=4,5mm half threaded		
L mm	TITAN	STEEL
10	926-226-45010	926-326-45010
12	926-226-45012	926-326-45012
14	926-226-45014	926-326-45014
16	926-226-45016	926-326-45016
18	926-226-45018	926-326-45018
20	926-226-45020	926-326-45020
22	926-226-45022	926-326-45022
24	926-226-45024	926-326-45024
26	926-226-45026	926-326-45026
28	926-226-45028	926-326-45028
30	926-226-45030	926-326-45030
32	926-226-45032	926-326-45032
34	926-226-45034	926-326-45034
36	926-226-45036	926-326-45036
38	926-226-45038	926-326-45038
40	926-226-45040	926-326-45040
42	926-226-45042	926-326-45042
44	926-226-45044	926-326-45044
46	926-226-45046	926-326-45046
48	926-226-45048	926-326-45048
50	926-226-45050	926-326-45050
55	926-226-45055	926-326-45055
60	926-226-45060	926-326-45060
Core hole for screw head:		

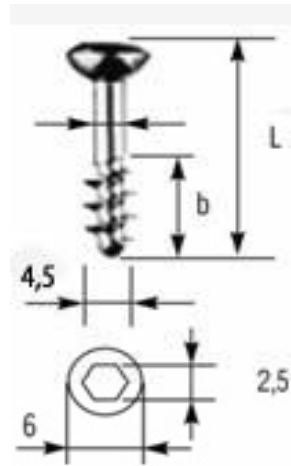

UNIVERSAL SCREWS, NUTS, WASHERS

Cancellous bone screw

d=4,0mm half threaded		
L mm	TITAN	STEEL
10	926-226-40010	926-326-40010
12	926-226-40012	926-326-40012
14	926-226-40014	926-326-40014
16	926-226-40016	926-326-40016
18	926-226-40018	926-326-40018
20	926-226-40020	926-326-40020
22	926-226-40022	926-326-40022
24	926-226-40024	926-326-40024
26	926-226-40026	926-326-40026
28	926-226-40028	926-326-40028
30	926-226-40030	926-326-40030
32	926-226-40032	926-326-40032
34	926-226-40034	926-326-40034
36	926-226-40036	926-326-40036
38	926-226-40038	926-326-40038
40	926-226-40040	926-326-40040
42	926-226-40042	926-326-40042
44	926-226-40044	926-326-40044
46	926-226-40046	926-326-40046
48	926-226-40048	926-326-40048
50	926-226-40050	926-326-40050
55	926-226-40055	926-326-40055
60	926-226-40060	926-326-40060
Core hole for screw head:		

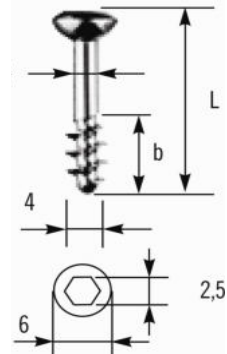

Cancellous bone screw

d=4,0 mm, fully threaded		
L mm	TITAN	STEEL
10	911-211-40010	911-311-40010
12	911-211-40012	911-311-40012
14	911-211-40014	911-311-40014
16	911-211-40016	911-311-40016
18	911-211-40018	911-311-40018
20	911-211-40020	911-311-40020
22	911-211-40022	911-311-40022
24	911-211-40024	911-311-40024
26	911-211-40026	911-311-40026
28	911-211-40028	911-311-40028
30	911-211-40030	911-311-40030
32	911-211-40032	911-311-40032
34	911-211-40034	911-311-40034
36	911-211-40036	911-311-40036
38	911-211-40038	911-311-40038
40	911-211-40040	911-311-40040
42	911-211-40042	911-311-40042
44	911-211-40044	911-311-40044
46	911-211-40046	911-311-40046
48	911-211-40048	911-311-40048
50	911-211-40050	911-311-40050
55	911-211-40055	911-311-40055
60	911-211-40060	911-311-40060

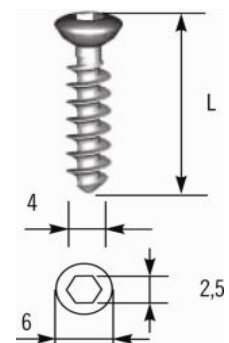

Cancellous bone screw

d=4mm (short thread)			
L mm	b mm	TITAN	STEEL
10	5	910-210-40010	910-310-40010
12	5	910-210-40012	910-310-40012
14	5	910-210-40014	910-310-40014
16	6	910-210-40016	910-310-40016
18	7	910-210-40018	910-310-40018
20	8	910-210-40020	910-310-40020
22	9	910-210-40022	910-310-40022
24	10	910-210-40024	910-310-40024
26	12	910-210-40026	910-310-40026
28	14	910-210-40028	910-310-40028
30	14	910-210-40030	910-310-40030
32.5	14	910-210-40032	910-310-40032
35	14	910-210-40035	
37.5	14	910-210-40375	
40	14	910-210-40040	910-310-40040
42.5	15	910-210-40425	
45	15	910-210-40045	910-310-40045
47.5	15	910-210-40475	
50	15	910-210-40050	910-310-40050
55	15	910-210-40055	910-310-40055
60	15	910-210-40060	910-310-40060
Core hole for screw thread:			
d = 2,5 mm			

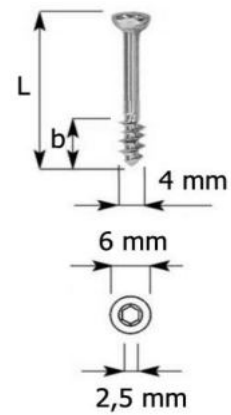

Cancellous bone screw

d=6,5 Type A		
L mm	TITAN	STEEL
25	912-212-65025	912-312-65025
30	912-212-65030	912-312-65030
35	912-212-65035	912-312-65035
40	912-212-65040	912-312-65040
45	912-212-65045	912-312-65045
50	912-212-65050	912-312-65050
55	912-212-65055	912-312-65055
60	912-212-65060	912-312-65060
65	912-212-65065	912-312-65065
70	912-212-65070	912-312-65070
75	912-212-65075	912-312-65075
80	912-212-65080	912-312-65080
85	912-212-65085	912-312-65085
90	912-212-65090	912-312-65090
95	912-212-65095	912-312-65095
100	912-212-65100	912-312-65100
105	912-212-65105	912-312-65105
110	912-212-65110	912-312-65110
115	912-212-65115	912-312-65115
120	912-212-65120	912-312-65120
125	912-212-65125	912-312-65125
130	912-212-65130	912-312-65130
Core hole for screw thread:		
d = 3,2 mm		

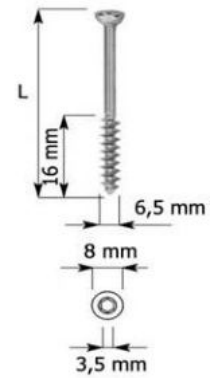

Cancellous bone screw

d=6,5 Type B		
L mm	TITAN	STEEL
40	913-213-65040	913-313-65040
45	913-213-65045	913-313-65045
50	913-213-65050	913-313-65050
55	913-213-65055	913-313-65055
60	913-213-65060	913-313-65060
65	913-213-65065	913-313-65065
70	913-213-65070	913-313-65070
75	913-213-65075	913-313-65075
80	913-213-65080	913-313-65080
85	913-213-65085	913-313-65085
90	913-213-65090	913-313-65090
95	913-213-65095	913-313-65095
100	913-213-65100	913-313-65100
105	913-213-65105	913-313-65105
110	913-213-65110	913-313-65110
120	913-213-65120	913-313-65120
130	913-213-65130	913-313-65130
140	913-213-65140	913-313-65140
Core hole for screw thread:		
	d = 3,2 mm	

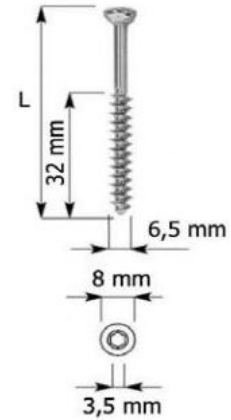

UNIVERSAL SCREWS, NUTS, WASHERS

Cancellous bone screw

d=6,5mm, fully threaded		
L mm	TITAN	STEEL
20	914-214-65020	914-314-65020
25	914-214-65025	914-314-65025
30	914-214-65030	914-314-65030
35	914-214-65035	914-314-65035
40	914-214-65040	914-314-65040
45	914-214-65045	914-314-65045
50	914-214-65050	914-314-65050
55	914-214-65055	914-314-65055
60	914-214-65060	914-314-65060
65	914-214-65065	914-314-65065
70	914-214-65070	914-314-65070
75	914-214-65075	914-314-65075
80	914-214-65080	914-314-65080
85	914-214-65085	914-314-65085
90	914-214-65090	914-314-65090
95	914-214-65095	914-314-65095
100	914-214-65100	914-314-65100
105	914-214-65105	914-314-65105
110	914-214-65110	914-314-65110
115	914-214-65115	914-314-65115
120	914-214-65120	914-314-65120
125	914-214-65125	914-314-65125
130	914-214-65130	914-314-65130
135	914-214-65135	914-314-65135
140	914-214-65140	914-314-65140
145	914-214-65145	914-314-65145
150	914-214-65150	914-314-65150

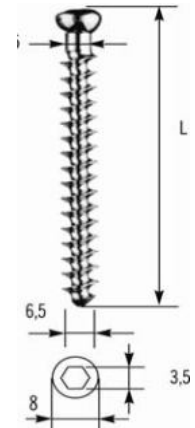

Cancellous bone screw

d=6,5mm, half threaded		
L mm	TITAN	STEEL
25	926-226-65025	926-326-65025
30	926-226-65030	926-326-65030
35	926-226-65035	926-326-65035
40	926-226-65040	926-326-65040
45	926-226-65045	926-326-65045
50	926-226-65050	926-326-65050
55	926-226-65055	926-326-65055
60	926-226-65060	926-326-65060
65	926-226-65065	926-326-65065
70	926-226-65070	926-326-65070
75	926-226-65075	926-326-65075
80	926-226-65080	926-326-65080
85	926-226-65085	926-326-65085
90	926-226-65090	926-326-65090
95	926-226-65095	926-326-65095
100	926-226-65100	926-326-65100
105	926-226-65105	926-326-65105
110	926-226-65110	926-326-65110
115	926-226-65115	926-326-65115
120	926-226-65120	926-326-65120
125	926-226-65125	926-326-65125
130	926-226-65130	926-326-65130
135	926-226-65135	926-326-65135
140	926-226-65140	926-326-65140
145	926-226-65145	926-326-65145
150	926-226-65150	926-326-65150



Cannulated cancellous bone screw

d=4,0 (short thread)			
L mm	b mm	TITAN	STEEL
10	5	915-215-40010	915-315-40010
12	5	915-215-40012	915-315-40012
14	5	915-215-40014	915-315-40014
16	6	915-215-40016	915-315-40016
18	7	915-215-40018	915-315-40018
20	8	915-215-40020	915-315-40020
22	9	915-215-40022	915-315-40022
24	10	915-215-40024	915-315-40024
26	12	915-215-40026	915-315-40026
28	14	915-215-40028	915-315-40028
30	14	915-215-40030	915-315-40030
32,5	14	915-215-40032	915-315-40032
35	14	915-215-40035	915-315-40035
37,5	14	915-215-40037	915-315-40037
40	14	915-215-40040	915-315-40040
42,5	15	915-215-40042	915-315-40042
45	15	915-215-40045	915-315-40045
47,5	15	915-215-40047	915-315-40047
50	15	915-215-40050	915-315-40050
55	15	915-215-40055	915-315-40055
60	15	915-215-40060	915-315-40060
Core hole for screw head:			
d = 2,6 mm			

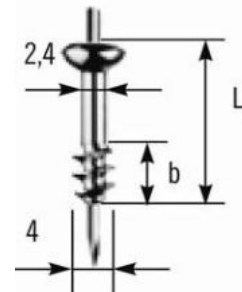

Cannulated cancellous bone screw

d=4,0 (fully thread)		
L mm	TITAN	STEEL
10	917-217-40010	917-317-40010
12	917-217-40012	917-317-40012
14	917-217-40014	917-317-40014
16	917-217-40016	917-317-40016
18	917-217-40018	917-317-40018
20	917-217-40020	917-317-40020
22	917-217-40022	917-317-40022
24	917-217-40024	917-317-40024
26	917-217-40026	917-317-40026
28	917-217-40028	917-317-40028
30	917-217-40030	917-317-40030
32	917-217-40032	917-317-40032
35	917-217-40035	917-317-40035
37	917-217-40037	917-317-40037
40	917-217-40040	917-317-40040
42	917-217-40042	917-317-40042
45	917-217-40045	917-317-40045
47	917-217-40047	917-317-40047
50	917-217-40050	917-317-40050
55	917-217-40055	917-317-40055
60	917-217-40060	917-317-40060
Kirschner boring wire:		
	d = 1 mm	
Core hole for screw thread:		
	d = 2,6 mm	

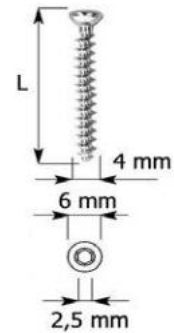

Cannulated cancellous bone screw

d=6,5 type A		
L mm	TITAN	STEEL
25	918-218-65025	918-318-65025
30	918-218-65030	918-318-65030
35	918-218-65035	918-318-65035
40	918-218-65040	918-318-65040
45	918-218-65045	918-318-65045
50	918-218-65050	918-318-65050
55	918-218-65055	918-318-65055
60	918-218-65060	918-318-65060
65	918-218-65065	918-318-65065
70	918-218-65070	918-318-65070
75	918-218-65075	918-318-65075
80	918-218-65080	918-318-65080
85	918-218-65085	918-318-65085
90	918-218-65090	918-318-65090
95	918-218-65095	918-318-65095
100	918-218-65100	918-318-65100
105	918-218-65105	918-318-65105
110	918-218-65110	918-318-65110
115	918-218-65115	918-318-65115
120	918-218-65120	918-318-65120
125	918-218-65125	918-318-65125
130	918-218-65130	918-318-65040
Kirschner boring wire:		
	d = 2 mm	
Core hole for screw thread:		
	d = 3,5 mm	

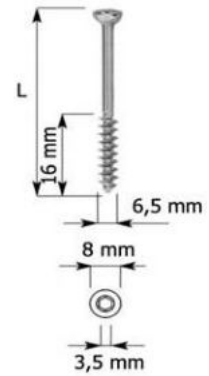

Cannulated cancellous bone screw

d=6,5 type B		
L mm	TITAN	STEEL
40	919-219-65040	919-319-65040
45	919-219-65045	919-319-65045
50	919-219-65050	919-319-65050
55	919-219-65055	919-319-65055
60	919-219-65060	919-319-65060
65	919-219-65065	919-319-65065
70	919-219-65070	919-319-65070
75	919-219-65075	919-319-65075
80	919-219-65080	919-319-65080
85	919-219-65085	919-319-65085
90	919-219-65090	919-319-65090
95	919-219-65095	919-319-65095
100	919-219-65100	919-319-65100
105	919-219-65105	919-319-65105
110	919-219-65110	919-319-65110
120	919-219-65120	919-319-65120
130	919-219-65130	919-319-65130
140	919-219-65140	919-319-65140
Kirschner boring wire:		
	d = 2 mm	
Core hole for screw thread:		
	d = 3,5 mm	

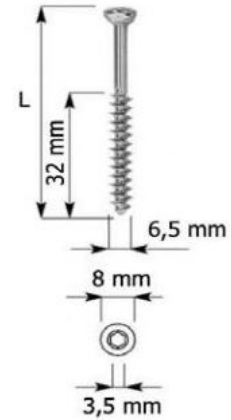

Cannulated cancellous bone screw

d=6,5 type C		
L mm	TITAN	STEEL
14	920-220-65014	920-320-65014
16	920-220-65016	920-320-65016
18	920-220-65018	920-320-65018
20	920-220-65020	920-320-65020
22	920-220-65022	920-320-65022
24	920-220-65024	920-320-65024
25	920-220-65025	920-320-65025
30	920-220-65030	920-320-65030
35	920-220-65035	920-320-65035
40	920-220-65040	920-320-65040
45	920-220-65045	920-320-65045
50	920-220-65050	920-320-65050
55	920-220-65055	920-320-65055
60	920-220-65060	920-320-65060
65	920-220-65065	920-320-65065
70	920-220-65070	920-320-65070
75	920-220-65075	920-320-65075
80	920-220-65080	920-320-65080
85	920-220-65085	920-320-65085
90	920-220-65090	920-320-65090
95	920-220-65095	920-320-65095
100	920-220-65100	920-320-65100
105	920-220-65105	920-320-65105
110	920-220-65110	920-320-65110
Kirschner boring wire:		
	d = 2 mm	
Core hole for screw thread:		
	d = 3,5 mm	

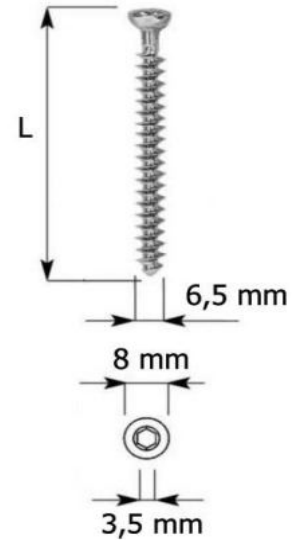

UNIVERSAL SCREWS, NUTS, WASHERS

Cannulated bone screw

d=4,0mm, half threaded		
L mm	TITAN	STEEL
16	916-216-40016	916-316-40016
18	916-216-40018	916-316-40018
20	916-216-40020	916-316-40020
22	916-216-40022	916-316-40022
24	916-216-40024	916-316-40024
26	916-216-40026	916-316-40026
28	916-216-40028	916-316-40028
30	916-216-40030	916-316-40030
32	916-216-40032	916-316-40032
34	916-216-40034	916-316-40034
36	916-216-40036	916-316-40036
38	916-216-40038	916-316-40038
40	916-216-40040	916-316-40040
42	916-216-40042	916-316-40042
44	916-216-40044	916-316-40044
46	916-216-40046	916-316-40046
48	916-216-40048	916-316-40048
50	916-216-40050	916-316-40050

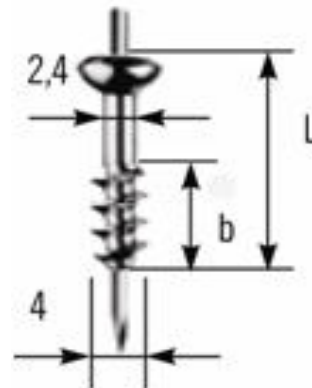

Cannulated bone screw

d=4,0mm, fully threaded		
L mm	TITAN	STEEL
16	917-217-40016	917-317-40016
18	917-217-40018	917-317-40018
20	917-217-40020	917-317-40020
22	917-217-40022	917-317-40022
24	917-217-40024	917-317-40024
26	917-217-40026	917-317-40026
28	917-217-40028	917-317-40028
30	917-217-40030	917-317-40030
32	917-217-40032	917-317-40032
34	917-217-40034	917-317-40034
36	917-217-40036	917-317-40036
38	917-217-40038	917-317-40038
40	917-217-40040	917-317-40040
42	917-217-40042	917-317-40042
44	917-217-40044	917-317-40044
46	917-217-40046	917-317-40046
48	917-217-40048	917-317-40048
50	917-217-40050	917-317-40050

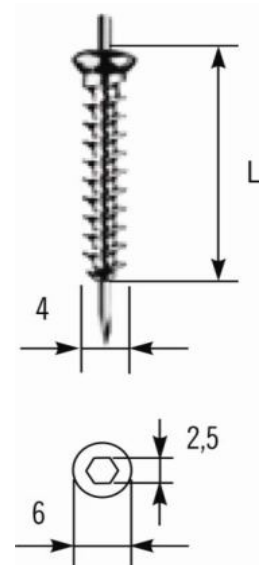

Cannulated bone screw

d=7,0 mm, 16mm threaded		
L mm	TITAN	STEEL
60	918-218-70060	918-318-70060
65	918-218-70065	918-318-70065
70	918-218-70070	918-318-70070
75	918-218-70075	918-318-70075
80	918-218-70080	918-318-70080
85	918-218-70085	918-318-70085
90	918-218-70090	918-318-70090
95	918-218-70095	918-318-70095
100	918-218-70100	918-318-70100
105	918-218-70105	918-318-70105
110	918-218-70110	918-318-70110
115	918-218-70115	918-318-70115
120	918-218-70120	918-318-70120
125	918-218-70125	918-318-70125
130	918-218-70130	918-318-70130
135	918-218-70135	918-318-70135
140	918-218-70140	918-318-70140
145	918-218-70145	918-318-70145
150	918-218-70150	918-318-70150

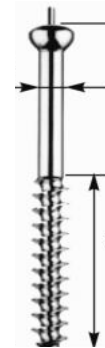

Cannulated bone screw

d=7,0 mm, half threaded		
L mm	TITAN	STEEL
20	916-216-70020	916-316-70020
25	916-216-70025	916-316-70025
30	916-216-70030	916-316-70030
35	916-216-70035	916-316-70035
40	916-216-70040	916-316-70040
45	916-216-70045	916-316-70045
50	916-216-70050	916-316-70050
55	916-216-70055	916-316-70055
60	916-216-70060	916-316-70060
65	916-216-70065	916-316-70065
70	916-216-70070	916-316-70070
75	916-216-70075	916-316-70075
80	916-216-70080	916-316-70080
85	916-216-70085	916-316-70085
90	916-216-70090	916-316-70090
95	916-216-70095	916-316-70095
100	916-216-70100	916-316-70100
105	916-216-70105	916-316-70105
110	916-216-70110	916-316-70110
115	916-216-70115	916-316-70115
120	916-216-70120	916-316-70120
125	916-216-70125	916-316-70125
130	916-216-70130	916-316-70130
135	916-216-70135	916-316-70135
140	916-216-70140	916-316-70140
145	916-216-70145	916-316-70145
150	916-216-70150	916-316-70150

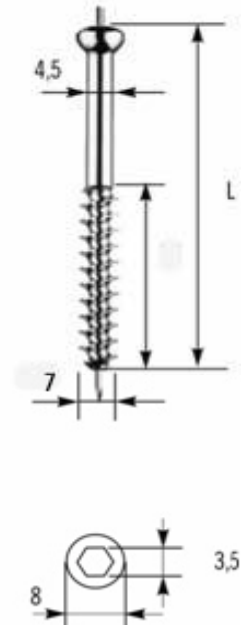

Cannulated bone screw

d=7,0 mm, fully threaded

L mm	TITAN	STEEL
10	917-217-70010	917-317-70010
12	917-217-70012	917-317-70012
14	917-217-70014	917-317-70014
16	917-217-70016	917-317-70016
18	917-217-70018	917-317-70018
20	917-217-70020	917-317-70020
22	917-217-70022	917-317-70022
24	917-217-70024	917-317-70024
26	917-217-70026	917-317-70026
28	917-217-70028	917-317-70028
30	917-217-70030	917-317-70030
32	917-217-70032	917-317-70032
34	917-217-70034	917-317-70034
36	917-217-70036	917-317-70036
38	917-217-70038	917-317-70038
40	917-217-70040	917-317-70040
42	917-217-70042	917-317-70042
44	917-217-70044	917-317-70044
46	917-217-70046	917-317-70046
48	917-217-70048	917-317-70048
50	917-217-70050	917-317-70050

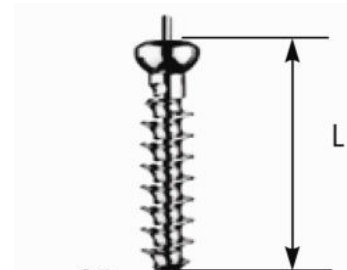

Locking bone screw

d=4 mm (partially threaded)			
L/I mm	ANODISED TITAN	TITAN	STEEL
20/8	926-126-40020	926-226-40020	926-326-40020
22/9	926-126-40022	926-226-40022	926-326-40022
24/10	926-126-40024	926-226-40024	926-326-40024
26/12	926-126-40026	926-226-40026	926-326-40026
28/14	926-126-40028	926-226-40028	926-326-40028
30/14	926-126-40030	926-226-40030	926-326-40030
35/14	926-126-40035	926-226-40035	926-326-40035
36/14	926-126-40036	926-226-40036	926-326-40036
40/14	926-126-40040	926-226-40040	926-326-40040
42/14	926-126-40042	926-226-40042	926-326-40042
45/15	926-126-40045	926-226-40045	926-326-40045
46/15	926-126-40046	926-226-40046	926-326-40046
48/15	926-126-40048	926-226-40048	926-326-40048
50/15	926-126-40050	926-226-40050	926-326-40050
55/15	926-126-40055	926-226-40055	926-326-40055
60/15	926-126-40060	926-226-40060	926-326-40060
65/15	926-126-40065	926-226-40065	926-326-40065
70/15	926-126-40068	926-226-40068	926-326-40068
Core hole for screw thread:			
	d = 3,2mm		

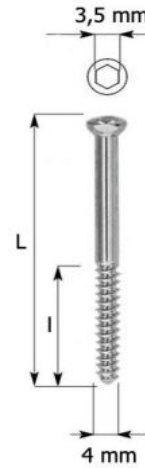

Locking bone screw

d=4.0 mm			
L mm	ANODISED TITAN	TITAN	STEEL
20	921-121-40020	921-221-40020	921-321-40020
22	921-121-40022	921-221-40022	921-321-40022
24	921-121-40024	921-221-40024	921-321-40024
26	921-121-40026	921-221-40026	921-321-40026
28	921-121-40028	921-221-40028	921-321-40028
30	921-121-40030	921-221-40030	921-321-40030
32	921-121-40032	921-221-40032	921-321-40032
34	921-121-40034	921-221-40034	921-321-40034
36	921-121-40036	921-221-40036	921-321-40036
38	921-121-40038	921-221-40038	921-321-40038
40	921-121-40040	921-221-40040	921-321-40040
42	921-121-40042	921-221-40042	921-321-40042
44	921-121-40044	921-221-40044	921-321-40044
46	921-121-40046	921-221-40046	921-321-40046
48	921-121-40048	921-221-40048	921-321-40048
50	921-121-40050	921-221-40050	921-321-40050
52	921-121-40052	921-221-40052	921-321-40052
54	921-121-40054	921-221-40054	921-321-40054
56	921-121-40056	921-221-40056	921-321-40056
58	921-121-40058	921-221-40058	921-321-40058
60	921-121-40060	921-221-40060	921-321-40060
62	921-121-40062	921-221-40062	921-321-40062
64	921-121-40064	921-221-40064	921-321-40064
66	921-121-40066	921-221-40066	921-321-40066
68	921-121-40068	921-221-40068	921-321-40068
70	921-121-40070	921-221-40070	921-321-40070
72	921-121-40072	921-221-40072	921-321-40072
76	921-121-40076	921-221-40076	921-321-40076
80	921-121-40080	921-221-40080	921-321-40080

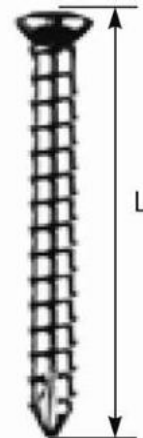

Locking bone screw

d=5 mm (partially threaded)			
L mm	ANODISED TITAN	TITAN	STEEL
55	926-226-50055	926-226-50055	926-326-50055
60	926-226-50060	926-226-50060	926-326-50060
65	926-226-50065	926-226-50065	926-326-50065
70	926-226-50070	926-226-50070	926-326-50070
75	926-226-50075	926-226-50075	926-326-50075
80	926-226-50080	926-226-50080	926-326-50080
85	926-226-50085	926-226-50085	926-326-50085
90	926-226-50090	926-226-50090	926-326-50090
95	926-226-50095	926-226-50095	926-326-50095
100	926-226-50100	926-226-50100	926-326-50100
105	926-226-50105	926-226-50105	926-326-50105
110	926-226-50110	926-226-50110	926-326-50110
115	926-226-50115	926-226-50115	926-326-50115
120	926-226-50120	926-226-50120	926-326-50120
125	926-226-50125	926-226-50125	926-326-50125
130	926-226-50130	926-226-50130	926-326-50130
135	926-226-50135	926-226-50135	926-326-50135
Core hole for screw thread:			
	d = 3,5 mm		

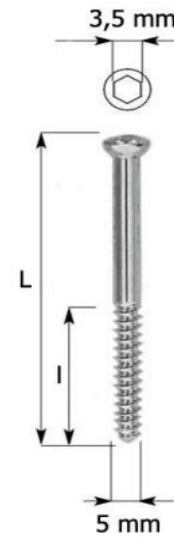

Locking bone screw

d=5.0 mm

L mm	ANODISED TITAN	TITAN	STEEL
24	921-121-50024	921-221-50024	921-321-50024
26	921-121-50026	921-221-50026	921-321-50026
28	921-121-50028	921-221-50028	921-321-50028
30	921-121-50030	921-221-50030	921-321-50030
32	921-121-50032	921-221-50032	921-321-50032
34	921-121-50034	921-221-50034	921-321-50034
36	921-121-50036	921-221-50036	921-321-50036
38	921-121-50038	921-221-50038	921-321-50038
40	921-121-50040	921-221-50040	921-321-50040
42	921-121-50042	921-221-50042	921-321-50042
44	921-121-50044	921-221-50044	921-321-50044
46	921-121-50046	921-221-50046	921-321-50046
48	921-121-50048	921-221-50048	921-321-50048
50	921-121-50050	921-221-50050	921-321-50050
52	921-121-50052	921-221-50052	921-321-50052
54	921-121-50054	921-221-50054	921-321-50054
56	921-121-50056	921-221-50056	921-321-50056
58	921-121-50058	921-221-50058	921-321-50058
60	921-121-50060	921-221-50060	921-321-50060
62	921-121-50062	921-221-50062	921-321-50062
66	921-121-50066	921-221-50066	921-321-50066
70	921-121-50070	921-221-50070	921-321-50070
72	921-121-50072	921-221-50072	921-321-50072
76	921-121-50076	921-221-50076	921-321-50076
80	921-121-50080	921-221-50080	921-321-50080

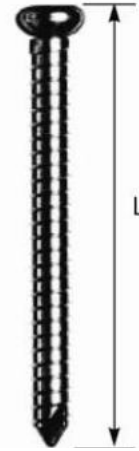

UNIVERSAL SCREWS, NUTS, WASHERS

Locking bone screw

d=6.5 mm l=20/32 mm		
L mm	TITAN	STEEL
55/20	921-221-20055	921-321-20055
60/20	921-221-20060	921-321-20060
65/20	921-221-20065	921-321-20065
70/20	921-221-20070	921-321-20070
75/20	921-221-20075	921-321-20075
80/32	921-221-32080	921-321-32080
85/32	921-221-32085	921-321-32085
90/32	921-221-32090	921-321-32090
95/32	921-221-32095	921-321-32095
100/32	921-221-32100	921-321-32100
105/32	921-221-32105	921-321-32105
110/32	921-221-32110	921-321-32110
115/32	921-221-32115	921-321-32115
120/32	921-221-32120	921-321-32120
125/32	921-221-32125	921-321-32125
130/32	921-221-32130	921-321-32130
Core hole for screw thread:		
	d = 3,2 mm	

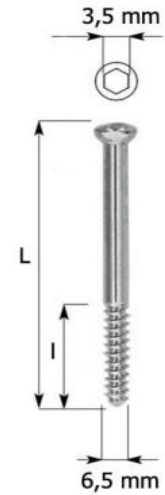

d=6.5 mm l=16 mm		
L mm	TITAN	STEEL
55	921-221-65055	921-321-65055
60	921-221-65060	921-321-65060
65	921-221-65065	921-321-65065
70	921-221-65070	921-321-65070
75	921-221-65075	921-321-65075
80	921-221-65080	921-321-65080
85	921-221-65085	921-321-65085
90	921-221-65090	921-321-65090
95	921-221-65095	921-321-65095
100	921-221-65100	921-321-65100
105	921-221-65105	921-321-65105
110	921-221-65110	921-321-65110
115	921-221-65115	921-321-65115
120	921-221-65120	921-321-65120
125	921-221-65125	921-321-65125
130	921-221-65130	921-321-65130
Core hole for screw thread:		
	d = 3,5 mm	

UNIVERSAL SCREWS, NUTS, WASHERS

Pertrochanter screw

D mm	STEEL	TITAN
70	934-334-00070	934-234-00070
75	934-334-00075	934-234-00075
80	934-334-00080	934-234-00080
85	934-334-00085	934-234-00085
90	934-334-00090	934-234-00090
95	934-334-00095	934-234-00095
100	934-334-00100	934-234-00100
105	934-334-00105	934-234-00105
110	934-334-00110	934-234-00110
115	934-334-00115	934-234-00115
120	934-334-00120	934-234-00120
125	934-334-00125	934-234-00125
130	934-334-00130	934-234-00130
135	934-334-00135	934-234-00135
140	934-334-00140	934-234-00140
145	934-334-00145	934-234-00145

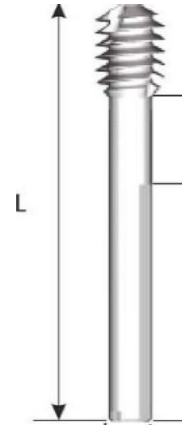

UNIVERSAL SCREWS, NUTS, WASHERS

Interference screw

L mm	d mm	TITAN	STEEL
20	7	924-224-07020	924-324-07020
25	7	924-224-07025	924-324-07025
30	7	924-224-07030	924-324-07030
35	7	924-224-07035	924-324-07035
40	7	924-224-07040	924-324-07040
20	8	924-224-08020	924-324-08020
25	8	924-224-08025	924-324-08025
30	8	924-224-08030	924-324-08030
35	8	924-224-08035	924-324-08035
40	8	924-224-07040	924-324-07040
20	9	924-224-09020	924-324-09020
25	9	924-224-09025	924-324-09025
30	9	924-224-09030	924-324-09030
35	9	924-224-09035	924-324-09035
40	9	924-224-09040	924-324-09040

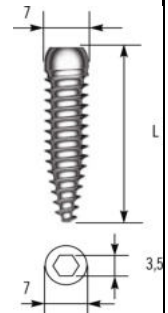

Cannulated interference screw

L mm	d mm	TITAN	STEEL
20	7	925-225-07020	925-325-07020
25	7	925-225-07025	925-325-07025
30	7	925-225-07030	925-325-07030
35	7	925-225-07035	925-325-07035
40	7	925-225-07040	925-325-07040
20	8	925-225-08020	925-325-08020
25	8	925-225-08025	925-325-08025
30	8	925-225-08030	925-325-08030
35	8	925-225-08035	925-325-08035
40	8	925-225-08040	925-325-08040
20	9	925-225-09020	925-325-09020
25	9	925-225-09025	925-325-09025
30	9	925-225-09030	925-325-09030
35	9	925-225-09035	925-325-09035
40	9	925-225-09040	925-325-09040

Locking screw for angle stabilised plate

d=3,5 mm		
L mm	TITAN	STEEL
16	901-201-35016	901-301-35016
18	901-201-35018	901-301-35018
20	901-201-35020	901-301-35020
22	901-201-35022	901-301-35022
24	901-201-35024	901-301-35024
26	901-201-35026	901-301-35026
28	901-201-35028	901-301-35028
30	901-201-35030	901-301-35030

d=4,5 mm		
L mm	TITAN	STEEL
20	901-201-45020	901-301-45020
22	901-201-45022	901-301-45022
24	901-201-45024	901-301-45024
26	901-201-45026	901-301-45026
28	901-201-45028	901-301-45028
30	901-201-45030	901-301-45030
32	901-201-45032	901-301-45032
34	901-201-45034	901-301-45034
36	901-201-45036	901-301-45036
38	901-201-45038	901-301-45038
40	901-201-45040	901-301-45040
42	901-201-45042	901-301-45042
44	901-201-45044	901-301-45044

d=6,0 mm		
L mm	TITAN	STEEL
40	901-201-60040	901-301-60040
42	901-201-60042	901-301-60042
44	901-201-60044	901-301-60044
46	901-201-60046	901-301-60046
48	901-201-60048	901-301-60048
50	901-201-60050	901-301-60050
52	901-201-60052	901-301-60052
54	901-201-60054	901-301-60054
56	901-201-60056	901-301-60056



Schanz screw

SIZE	STEEL
3x60x15 mm	953-353-03060
3x80x15 mm	953-353-03080
3x100x15 mm	953-353-03100
3x120x15 mm	953-353-03120
4x100x20 mm	953-353-04100
4x120x20 mm	953-353-04120
4x150x20 mm	953-353-04150
4x170x20 mm	953-353-04170
4,5x100x30 mm	953-353-45100
4,5x120x30 mm	953-353-45120
4,5x150x30 mm	953-353-45150
4,5x180x40 mm	953-353-45180
4,5x200x40 mm	953-353-45200
4,5x250x40 mm	953-353-45250
5x100x30 mm	953-353-05100
5x120x30 mm	953-353-05120
5x150x30 mm	953-353-05150
5x180x40 mm	953-353-05180
5x200x40 mm	953-353-05200
5x250x40 mm	953-353-05250
5x200x40 mm	953-353-15200
6x100x30 mm	953-353-06100
6x120x30 mm	953-353-06120
6x150x30 mm	953-353-06150
6x180x40 mm	953-353-06180
6x200x40 mm	953-353-06200
6x250x40 mm	953-353-06250
6x220x40 mm	953-353-16200





BIOTECH

II. Plates

1. Narrow bone plates
2. Broad bone plates
3. Small DC bone plates
4. Lengthening plates
5. Reconstruction plates
6. Quarter, one-third, semi tubular plates
7. Straight mini plates
8. Mini 1 / 4 plate
9. Mini angled plates
10. Angled plates
11. Cobra head plate
12. Anatomical femoral plate - distal lateral
13. Anatomical tibial plate - proximal lateral
14. Anatomical tibial plate - distal medial
15. T Plate
16. L Plate
17. Spoon plate
18. Cloverleaf plate
19. Small fragment T plates
20. Y Plates
21. Calcaneal plate
22. Olecranon plate

LCP- Low Contact Profile Narrow Bone Plate

L mm	No. of holes	TITAN	STEEL
34	2	942-242-12302	942-342-12302
52	3	942-242-12303	942-342-12303
70	4	942-242-12304	942-342-12304
88	5	942-242-12305	942-342-12305
106	6	942-242-12306	942-342-12306
124	7	942-242-12307	942-342-12307
142	8	942-242-12308	942-342-12308
160	9	942-242-12309	942-342-12309
178	10	942-242-12310	942-342-12310
196	11	942-242-12311	942-342-12311
214	12	942-242-12312	942-342-12312
232	13	942-242-12313	942-342-12313
250	14	942-242-12314	942-342-12314
268	15	942-242-12315	942-342-12315
286	16	942-242-12316	942-342-12316
304	17	942-242-12317	942-342-12317
322	18	942-242-12318	942-342-12318
340	19	942-242-12319	942-342-12319
358	20	942-242-12320	942-342-12320
376	21	942-242-12321	942-342-12321
394	22	942-242-12322	942-342-12322
412	23	942-242-12323	942-342-12323
430	24	942-242-12324	942-342-12324

with 3,5mm screw



LCP- Low Contact Profile Narrow Bone Plate

L mm	No. of holes	TITAN	STEEL
34	2	942-242-12002	942-342-12002
52	3	942-242-12003	942-342-12003
70	4	942-242-12004	942-342-12004
88	5	942-242-12005	942-342-12005
106	6	942-242-12006	942-342-12006
124	7	942-242-12007	942-342-12007
142	8	942-242-12008	942-342-12008
160	9	942-242-12009	942-342-12009
178	10	942-242-12010	942-342-12010
196	11	942-242-12011	942-342-12011
214	12	942-242-12012	942-342-12012
232	13	942-242-12013	942-342-12013
250	14	942-242-12014	942-342-12014
268	15	942-242-12015	942-342-12015
286	16	942-242-12016	942-342-12016
304	17	942-242-12017	942-342-12017
322	18	942-242-12018	942-342-12018
340	19	942-242-12019	942-342-12019
358	20	942-242-12020	942-342-12020
376	21	942-242-12021	942-342-12021
394	22	942-242-12022	942-342-12022
412	23	942-242-12023	942-342-12023
430	24	942-242-12024	942-342-12024

with 4,5mm screw



BROAD BONE PLATE

L mm	No. of holes	WITH ROUNDED HOLES		SELF-COMPRESSING	
		STEEL	TITAN	STEEL	TITAN
87	5	940-340-17005	940-240-17005	941-341-17005	941-241-17005
103	6	940-340-17006	940-240-17006	941-341-17006	941-241-17006
119	7	940-340-17007	940-240-17007	941-341-17007	941-241-17007
135	8	940-340-17008	940-240-17008	941-341-17008	941-241-17008
151	9	940-340-17009	940-240-17009	941-341-17009	941-241-17009
167	10	940-340-17010	940-240-17010	941-341-17010	941-241-17010
183	11	940-340-17011	940-240-17011	941-341-17011	941-241-17011
199	12	940-340-17012	940-240-17012	941-341-17012	941-241-17012
215	13	940-340-17013	940-240-17013	941-341-17013	941-241-17013
231	14	940-340-17014	940-240-17014	941-341-17014	941-241-17014
247	15	940-340-17015	940-240-17015	941-341-17015	941-241-17015
263	16	940-340-17016	940-240-17016	941-341-17016	941-241-17016
279	17	940-340-17017	940-240-17017	941-341-17017	941-241-17017
295	18	940-340-17018	940-240-17018	941-341-17018	941-241-17018
311	19	940-340-17019	940-240-17019	941-341-17019	941-241-17019
327	20	940-340-17020	940-240-17020	941-341-17020	941-241-17020
343	21	940-340-17021	940-240-17021	941-341-17021	941-241-17021
359	22	940-340-17022	940-240-17022	941-341-17022	941-241-17022
375	23	940-340-17023	940-240-17023	941-341-17023	941-241-17023
391	24	940-340-17024	940-240-17024	941-341-17024	941-241-17024
407	25	940-340-17025	940-240-17025	941-341-17025	941-241-17025
423	26	940-340-17026	940-240-17026	941-341-17026	941-241-17026

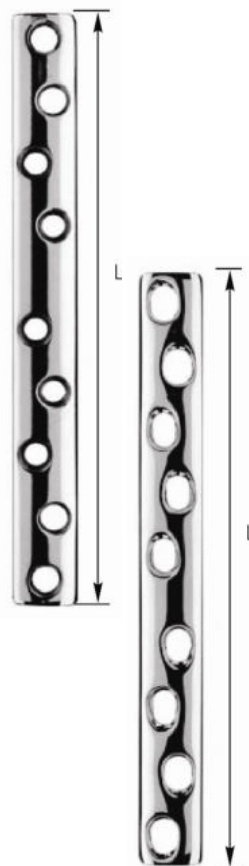

LC - Low Contact Profile BROAD BONE PLATE

L mm	No. of holes	STEEL	TITAN
87	5	942-342-17005	942-242-17005
103	6	942-342-17006	942-242-17006
119	7	942-342-17007	942-242-17007
135	8	942-342-17008	942-242-17008
151	9	942-342-17009	942-242-17009
167	10	942-342-17010	942-242-17010
183	11	942-342-17011	942-242-17011
199	12	942-342-17012	942-242-17012
215	13	942-342-17013	942-242-17013
231	14	942-342-17014	942-242-17014
247	15	942-342-17015	942-242-17015
263	16	942-342-17016	942-242-17016
279	17	942-342-17017	942-242-17017
295	18	942-342-17018	942-242-17018
311	19	942-342-17019	942-242-17019
327	20	942-342-17020	942-242-17020
343	21	942-342-17021	942-242-17021
359	22	942-342-17022	942-242-17022
375	23	942-342-17023	942-242-17023
391	24	942-342-17024	942-242-17024
407	25	942-342-17025	942-242-17025
423	26	942-342-17026	942-242-17026



Narrow bone plate

L mm	No. of holes	WITH ROUNDED HOLES		SELF-COMPRESSING	
		STEEL	TITAN	STEEL	TITAN
39	2	940-340-12002	940-240-12002	941-341-12002	941-241-12002
55	3	940-340-12003	940-240-12003	941-341-12003	941-241-12003
71	4	940-340-12004	940-240-12004	941-341-12004	941-241-12004
87	5	940-340-12005	940-240-12005	941-341-12005	941-241-12005
103	6	940-340-12006	940-240-12006	941-341-12006	941-241-12006
119	7	940-340-12007	940-240-12007	941-341-12007	941-241-12007
135	8	940-340-12008	940-240-12008	941-341-12008	941-241-12008
151	9	940-340-12009	940-240-12009	941-341-12009	941-241-12009
167	10	940-340-12010	940-240-12010	941-341-12010	941-241-12010
183	11	940-340-12011	940-240-12011	941-341-12011	941-241-12011
199	12	940-340-12012	940-240-12012	941-341-12012	941-241-12012
215	13	940-340-12013	940-240-12013	941-341-12013	941-241-12013
231	14	940-340-12014	940-240-12014	941-341-12014	941-241-12014
247	15	940-340-12015	940-240-12015	941-341-12015	941-241-12015
263	16	940-340-12016	940-240-12016	941-341-12016	941-241-12016
279	17	940-340-12017	940-240-12017	941-341-12017	941-241-12017
295	18	940-340-12018	940-240-12018	941-341-12018	941-241-12018
311	19	940-340-12019	940-240-12019	941-341-12019	941-241-12019
327	20	940-340-12020	940-240-12020	941-341-12020	941-241-12020
343	21	940-340-12021	940-240-12021	941-341-12021	941-241-12021
359	22	940-340-12022	940-240-12022	941-341-12022	941-241-12022
375	23	940-340-12023	940-240-12023	941-341-12023	941-241-12023
391	24	940-340-12024	940-240-12024	941-341-12024	941-241-12024



Small self-compressing plate

Dimension: 8 x 2 mm			
L mm	No. of holes	TITAN	STEEL
20	2	941-241-02020	941-341-02020
26	2	941-241-03026	941-341-03026
36	4	941-241-04036	941-341-04036
44	5	941-241-05044	941-341-05044
52	6	941-241-06052	941-341-06052

Dimension: 8 x 2,5 mm			
L mm	No. of holes	TITAN	STEEL
60	7	941-241-07060	941-341-07060
68	8	941-241-08068	941-341-08068
76	9	941-241-09076	941-341-09076
84	10	941-241-10084	941-341-10084
100	12	941-241-12100	941-341-12100

Dimension: 10 x 3 mm			
L mm	No. of holes	TITAN	STEEL
25	2	941-241-02025	941-341-02025
37	3	941-241-03037	941-341-03037
49	4	941-241-04049	941-341-04049
61	5	941-241-05061	941-341-05061
73	6	941-241-06073	941-341-06073
85	7	941-241-07085	941-341-07085
97	8	941-241-08097	941-341-08097
109	9	941-241-09109	941-341-09109
121	10	941-241-10121	941-341-10121
133	11	941-241-11133	941-341-11133
145	12	941-241-12145	941-341-12145



Locking Small self-compressing plate

L mm	No. of holes	TITAN	STEEL
25	2	954-254-02025	954-354-02025
37	3	954-254-03037	954-354-03037
49	4	954-254-04049	954-354-04049
61	5	954-254-05061	954-354-05061
73	6	954-254-06073	954-354-06073
85	7	954-254-07085	954-354-07085
97	8	954-254-08097	954-354-08097
109	9	954-254-09109	954-354-09109
121	10	954-254-10121	954-354-10121
145	12	954-254-12145	954-354-12145



Lengthening plate

Profile mm	No. of holes	L mm	cat. no.
11,5 x 4	4 + 4	135	943-343-08135
		145	943-343-08145
		155	943-343-08155
		165	943-343-08165
		175	943-343-08175
		185	943-343-08185
16,5 x 4,8	4 + 4	135	944-344-08135
		145	944-344-08145
		155	944-344-08155
		165	944-344-08165
	5 + 5	179	944-344-10179
		189	944-344-10189
	5 + 5	199	944-344-10199
		209	944-344-10209
		219	944-344-10219
		229	944-344-10229
		239	944-344-10239
	6 + 6	249	944-344-10249
		263	944-344-10263
		295	944-344-12295
	7 + 7	320	944-344-12320
		340	944-344-14340
			360

Reconstruction plate

Dimension:	12 x 3 mm	
No. of holes	STEEL	TITAN
3	945-345-12003	945-245-12003
4	945-345-12004	945-245-12004
5	945-345-12005	945-245-12005
6	945-345-12006	945-245-12006
7	945-345-12007	945-245-12007
8	945-345-12008	945-245-12008
9	945-345-12009	945-245-12009
10	945-345-12010	945-245-12010
11	945-345-12011	945-245-12011
12	945-345-12012	945-245-12012
13	945-345-12013	945-245-12013
14	945-345-12014	945-245-12014
15	945-345-12015	945-245-12015
16	945-345-12016	945-245-12016
18	945-345-12018	945-245-12018
20	945-345-12020	945-245-12020
22	945-345-12022	945-245-12022
Fixation screw:	d=4,5 mm and 6,5 mm	



Dimension:	10 x 3 mm	
No. of holes	STEEL	TITAN
3	945-345-10003	945-245-10003
4	945-345-10004	945-245-10004
5	945-345-10005	945-245-10005
6	945-345-10006	945-245-10006
7	945-345-10007	945-245-10007
8	945-345-10008	945-245-10008
9	945-345-10009	945-245-10009
10	945-345-10010	945-245-10010
11	945-345-10011	945-245-10011
12	945-345-10012	945-245-10012
13	945-345-10013	945-245-10013
15	945-345-10015	945-245-10015
16	945-345-10016	945-245-10016
18	945-345-10018	945-245-10018
20	945-345-10020	945-245-10020
22	945-345-10022	945-245-10022
Fixation screw:	d=3,5 mm and 4 mm	

Dimension:	8 x 2,7 mm	
No. of holes	STEEL	TITAN
4	945-345-08004	945-245-08004
6	945-345-08006	945-245-08006
8	945-345-08008	945-245-08008
10	945-345-08010	945-245-08010
12	945-345-08012	945-245-08012
14	945-345-08014	945-245-08014
16	945-345-08016	945-245-08016
18	945-345-08018	945-245-08018
Fixation screw:	d=2,7 mm	

Reconstruction plate bended

Dimension:	10 x 3 mm	
No. of holes	STEEL	TITAN
6	945-345-12106	945-245-12106
7	945-345-12107	945-245-12107
8	945-345-12108	945-245-12108
9	945-345-12109	945-245-12109
10	945-345-12110	945-245-12110
11	945-345-12111	945-245-12111
12	945-345-12112	945-245-12112
13	945-345-12113	945-245-12113
15	945-345-12115	945-245-12115
16	945-345-12116	945-245-12116
18	945-345-12118	945-245-12118
20	945-345-12120	945-245-12120
22	945-345-12122	945-245-12122
Fixation screw:	d=3,5 mm	



Quarter tubular, one-third tubular, semi-tubular plate

Quarter tubular			
L mm	No. of holes	TITAN	STEEL
23	3	946-246-25003	946-346-25003
31	4	946-246-25004	946-346-25004
39	5	946-246-25005	946-346-25005
47	6	946-246-25006	946-346-25006
55	7	946-246-25007	946-346-25007
63	8	946-246-25008	946-346-25008
Fixation screw:		d=2,7 mm	

One-third tubular			
L mm	No. of holes	TITAN	STEEL
25	2	946-246-33002	946-346-33002
37	3	946-246-33003	946-346-33003
49	4	946-246-33004	946-346-33004
61	5	946-246-33005	946-346-33005
73	6	946-246-33006	946-346-33006
85	7	946-246-33007	946-346-33007
97	8	946-246-33008	946-346-33008
109	9	946-246-33009	946-346-33009
121	10	946-246-33010	946-346-33010
145	12	946-246-33012	946-346-33012
Fixation screw:		d=3,5 mm and 4 mm	

Semi-tubular			
L mm	No. of holes	TITAN	STEEL
39	2	946-246-50002	946-346-50002
55	3	946-246-50003	946-346-50003
71	4	946-246-50004	946-346-50004
87	5	946-246-50005	946-346-50005
103	6	946-246-50006	946-346-50006
119	7	946-246-50007	946-346-50007
135	8	946-246-50008	946-346-50008
151	9	946-246-50009	946-346-50009
167	10	946-246-50010	946-346-50010
183	11	946-246-50011	946-346-50011
199	12	946-246-50012	946-346-50012
Fixation screw:		d=4,5 mm and 6,5 mm	



Straight mini bone plate

Profile: 4 x 1 mm			
L mm	No. of holes	TITAN	STEEL
15	3	941-241-04003	941-341-04003
20	4	941-241-04004	941-341-04004
25	5	941-241-04005	941-341-04005
30	6	941-241-04006	941-341-04006
Fixation screw:		d=1,5 mm	

Profile: 5 x 1 mm			
L mm	No. of holes	TITAN	STEEL
17	3	941-241-05003	941-341-05003
23	4	941-241-05004	941-341-05004
29	5	941-241-05005	941-341-05005
35	6	941-241-05006	941-341-05006
41	7	941-241-05007	941-341-05007
47	8	941-241-05008	941-341-05008
Fixation screw:		d=2 mm	

Profile: 8 x 2 mm			
L	No. of	TITAN	STEEL
17	2	941-241-08002	941-341-08002
25	3	941-241-08003	941-341-08003
33	4	941-241-08004	941-341-08004
41	5	941-241-08005	941-341-08005
49	6	941-241-08006	941-341-08006
57	7	941-241-08007	941-341-08007
65	8	941-241-08008	941-341-08008
Fixation screw:		d=2,7 mm	

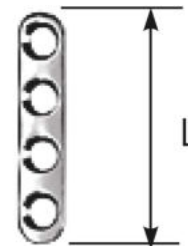

PLATES

mini plate 1/4

No. of holes	TITAN	STEEL
3	941-241-14003	941-341-14003
4	941-241-14004	941-341-14004
5	941-241-14005	941-341-14005
6	941-241-14006	941-341-14006
7	941-241-14007	941-341-14007
8	941-241-14008	941-341-14008



mini angled L-plate

Type	TITAN	STEEL
left	941-241-20901	941-341-20901
right	941-241-20902	941-341-20902



Type	TITAN	STEEL
left	941-241-10001	941-341-10001
right	941-241-10002	941-341-10002



Angled plate 95° self-compressing

l ₁ mm	no. of holes		
	5	6	7
35	949-349-05035	949-349-06035	949-349-07035
40	949-349-05040	949-349-06040	949-349-07040
50	949-349-05050	949-349-06050	949-349-07050
60	949-349-05060	949-349-06060	949-349-07060
70	949-349-05070	949-349-06070	949-349-07070
80	949-349-05080	949-349-06080	949-349-07080
90	949-349-05090	949-349-06090	949-349-07090

l ₁ mm	no. of holes		
	8	9	10
35	949-349-08035	949-349-09035	949-349-10035
40	949-349-08040	949-349-09040	949-349-10040
50	949-349-08050	949-349-09050	949-349-10050
60	949-349-08060	949-349-09060	949-349-10060
70	949-349-08070	949-349-09070	949-349-10070
80	949-349-08080	949-349-09080	949-349-10080
90	949-349-08090	949-349-09090	949-349-10090

l ₁ mm	no. of holes		
	11	12	14
50	949-349-11050	949-349-12050	949-349-14050
60	949-349-11060	949-349-12060	949-349-14060
70	949-349-11070	949-349-12070	949-349-14070
80	949-349-11080	949-349-12080	949-349-14080
90	949-349-11090	949-349-12090	949-349-14090

l ₁ mm	no. of holes	
	16	18
60	949-349-16060	949-349-18060
70	949-349-16070	949-349-18070
80	949-349-16080	949-349-18080
90	949-349-16090	949-349-18090

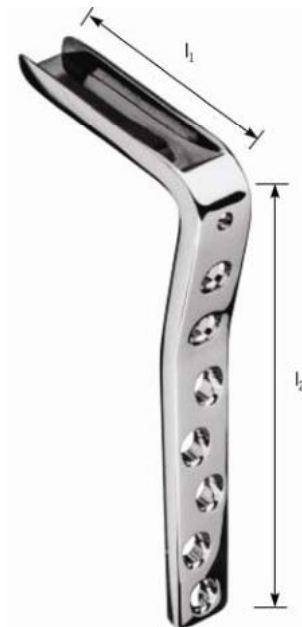

Angled plate 95° with round holes

	l2 = 92 mm	l2 = 124 mm
l1 mm	no. of holes	
	5	7
50	950-350-05050	950-350-07050
60	950-350-05060	950-350-07060
70	950-350-05070	950-350-07070
80	950-350-05080	950-350-07080

	l2 = 156 mm	l2 = 204 mm
l1 mm	no. of holes	
	9	12
50	950-350-09050	950-350-12050
60	950-350-09060	950-350-12060
70	950-350-09070	950-350-12070
80	950-350-09080	950-350-12080



Angled plate 130° self-compressing

	l2 = 60 mm	l2 = 104 mm	l2 = 152 mm
l1 mm	no. of holes		
	4	6	9
50	947-347-04050	947-347-06050	
60	947-347-04060	947-347-06060	
70	947-347-04070	947-347-06070	947-347-09070
75	947-347-04075		
80	947-347-04080	947-347-06080	947-347-09080
85	947-347-04085		
90	947-347-04090	947-347-06090	947-347-09090
95	947-347-04095		
100	947-347-04100		947-347-09100
105	947-347-04105		
110	947-347-04110		

	l2 = 200 mm	l2 = 232 mm
l1 mm	no. of holes	
	12	14
70	947-347-12070	947-347-14070
80	947-347-12080	
90	947-347-12090	

	l2 = 264 mm	l2 = 296 mm
l1 mm	no. of holes	
	16	16
70	947-347-16070	
80	947-347-16080	947-347-18080
90	947-347-16090	947-347-18090



Angled plate 130° with round holes

	l2 = 24 mm	l2 = 60 mm	l2 = 104 mm
l1 mm	no. of holes		
	1	4	6
50		948-348-04050	948-348-06050
60		948-348-04060	948-348-06060
70	948-348-01070	948-348-04070	948-348-06070
75	948-348-01075	948-348-04075	
80	948-348-01080	948-348-04080	948-348-06080
85	948-348-01085	948-348-04085	
90	948-348-01090	948-348-04090	948-348-06090
95	948-348-01095	948-348-04095	
100	948-348-01100	948-348-04100	
105	948-348-01105	948-348-04105	
110	948-348-01110	948-348-04110	

	l2 = 152 mm	l2 = 200 mm
l1 mm	no. of holes	
	9	12
70	948-348-09070	948-348-12070
80	948-348-09080	948-348-12080
90	948-348-09080	948-348-12090



Adolescent angled plate

	L mm	h mm	STEEL
90°	40	10	958-358-94010
90°	50	10	958-358-95010
90°	40	15	958-358-94015
90°	50	15	958-358-95015
90°	60	15	958-358-96015



Angled plate for children

h=8 mm		
	L mm	STEEL
90°	35	958-358-93508
90°	45	958-358-94508
100°	35	958-358-13508
100°	45	958-358-14508

h=7 mm		
	L mm	STEEL
90°	25	958-358-92507
90°	32	958-358-93207

h=12 mm		
	L mm	STEEL
90°	25	958-358-92512
90°	32	958-358-93212

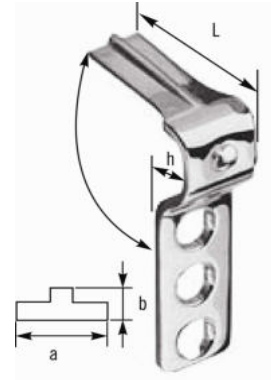

Cobra head plate

L mm	No. of holes on the tail	cat. no.
170	8	959-359-05008
186	9	959-359-05009
202	10	959-359-05010
218	11	959-359-05011



Anatomical femoral bone plate - distal lateral

L mm	No. of holes	cat. no.
left	7	959-359-06107
	9	959-359-06109
	11	959-359-06111
	13	959-359-06113
	15	959-359-06115

L mm	No. of holes	cat. no.
right	7	959-359-06207
	9	959-359-06209
	11	959-359-06211
	13	959-359-06213
	15	959-359-06215



Anatomical tibial bone plate - proximal, lateral

	no. of holes	STEEL	TITAN
left	5	959-359-07105	959-259-07105
	7	959-359-07107	959-259-07107
	9	959-359-07109	959-259-07109
	11	959-359-07111	959-259-07111
	13	959-359-07113	959-259-07113

	no. of holes	STEEL	TITAN
right	5	959-359-07205	959-259-07205
	7	959-359-07207	959-259-07207
	9	959-359-07209	959-259-07209
	11	959-359-07211	959-259-07211
	13	959-359-07213	959-259-07213



Anatomical tibial bone plate - distal, medial

	no. of holes	STEEL	TITAN
left	5	959-359-12105	959-259-12105
	7	959-359-12107	959-259-12107
	9	959-359-12109	959-259-12109
	11	959-359-12111	959-259-12111
	13	959-359-12113	959-259-12113

	no. of holes	STEEL	TITAN
right	5	959-359-12205	959-259-12205
	7	959-359-12207	959-259-12207
	9	959-359-12209	959-259-12209
	11	959-359-12211	959-259-12211
	13	959-359-12213	959-259-12213



T-supporting plate

No. of holes	STEEL
4	959-359-11004
5	959-359-11005
6	959-359-11006



T-plate

L mm	No. of holes	STEEL
68	3	959-359-10003
84	4	959-359-10004
100	5	959-359-10005
116	6	959-359-10006
132	7	959-359-10007
148	8	959-359-10008
164	9	959-359-10009
180	10	959-359-10010
196	11	959-359-10011
212	12	959-359-10012
228	13	959-359-10013



L - plate

L mm	No. of holes	cat. no.
right	4	959-359-17104
	5	959-359-17105
	6	959-359-17106
	8	959-359-17108

L mm	No. of holes	cat. no.
left	4	959-359-17204
	5	959-359-17205
	6	959-359-17206
	8	959-359-17208



Spoon-plate

L mm	No. of holes	cat. no.
100	5	959-359-08005
120	6	959-359-08006

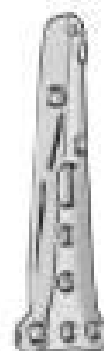

Cloverleaf plate

L mm	No. of holes	TITAN	STEEL
83.5	3	959-359-09003	959-259-09003
98	4	959-359-09004	959-259-09004
120	5	959-359-09005	959-259-09005
136	6	959-359-09006	959-259-09006



Small fragment T-plate

L mm	No. of holes		TITAN	STEEL
	on the head	on the tail		
49	3	3	959-259-13033	959-359-13033
67	3	5	959-259-13035	959-359-13035
56	4	4	959-259-13044	959-359-13044
78	4	6	959-259-13046	959-359-13046



Oblique small fragment T-plate

L mm	No. of holes		TITAN	STEEL
	on the head	on the tail	Plate thickness: 1.2 mm	
53	3	3	959-259-13133	959-359-13133
60	3	4	959-259-13134	959-359-13134
71	3	5	959-259-13135	959-359-13135



L mm	No. of holes		TITAN
	on the head	on the tail	Plate thickness: 2 mm
53	3	3	959-359-14133
60	3	4	
71	3	5	959-359-14135

Y-plate for humerus condyle

STEEL	TITAN
959-359-00010	959-259-00010



Y - plate

	No. of holes	STEEL	TITAN
right	9	959-359-0009	959-259-0009
left	9	959-359-1009	959-259-1009



calcaneal plate

length	TITAN	STEEL
60 mm	937-337-00060	937-237-00060
70 mm	937-337-00070	937-237-00070



Olecranon hook plate





no. of holes	STEEL	TITAN
4	938-338-00004	938-238-00004
5	938-338-00005	938-238-00005
7	938-338-00007	938-238-00007
9	938-338-00009	938-238-00009



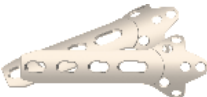

BIOTECH

Trauma Locking Compression Plate System

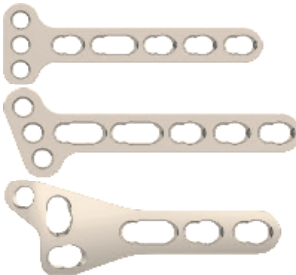
Art. No. Stainless steel	Art. No. Titan	DESCRIPTION	size			
		Humerus				
957-357-09003	957-257-09003	3.5mm LCP Cloverleaf Plate	3x88			
957-357-09004	957-257-09004		4x102			
957-357-09005	957-257-09005		5x118			
957-357-09006	957-257-09006		6x132			
957-357-10005	957-257-10005	3.5mm LCP Proximal Humerus Plate	5x86			
957-357-10006	957-257-10006		6x98			
957-357-10007	957-257-10007		7x110			
957-357-10008	957-257-10008		8x122			
957-357-12006	957-257-12006	3.5mm LCP Limited Contact Humerus Plate	6x11x86			
957-357-12007	957-257-12007		7x11x100			
957-357-12008	957-257-12008		8x11x112			
957-357-12009	957-257-12009		9x11x126			
957-357-12010	957-257-12010		10x11x138			
957-357-12012	957-257-12012		12x11x164			
957-357-12014	957-257-12014		14x11x190			
957-357-12016	957-257-12016		16x11x216			
957-357-12018	957-257-12018		18x11x242			
957-357-13007	957-257-13007	3.5mm LCP Distal Humerus Plate	7x80			
957-357-13009	957-257-13009		9x106			
957-357-13011	957-257-13011		11x132			
957-357-13013	957-257-13013		13x158			
957-357-13015	957-257-13015		15x184			
		Ulna and Radius				
957-357-14004	957-257-14004	3.5mm LCP Limited Contact Ulna / Radius Plate	4x11x58			
957-357-14005	957-257-14005		5x11x70			
957-357-14006	957-257-14006		6x11x84			
957-357-14007	957-257-14007		7x11x96			
957-357-14008	957-257-14008		8x11x110			
957-357-14009	957-257-14009		9x11x122			
957-357-14010	957-257-14010		10x11x136			
957-357-14011	957-257-14011		11x11x148			
957-357-14012	957-257-14012		12x11x162			
957-357-18350	957-257-18350		3.5mm LCP Small T Plate		3x50xL /R	
957-357-18460	957-257-18460				4x60xL /R	
957-357-18572	957-257-18572				5x72xL /R	
957-357-19352	957-257-19352	3x52xL				
957-357-29352	957-257-29352	3x52xR				
957-357-19462	957-257-19462	4x62xL				
957-357-29462	957-257-29462	4x62xR				
957-357-19574	957-257-19574	5x74xL				
957-357-29574	957-257-29574	5x74xR				
957-357-18246	957-257-18246	2+4x60xL/R				
957-357-19366	957-257-19366	3+3x66xL				
957-357-29366	957-257-29366	3+3x66xR				









BIOTECH

		Clavicle		
957-357-23005	957-257-23005	Clavicle Locking Hook Plate (Reconstruction)	5×18×86×L	
957-357-23007	957-257-23007		7×18×110×L	
957-357-23105	957-257-23105		5×18×86×R	
957-357-23107	957-257-23107		7×18×110×R	
957-357-25004	957-257-25004	Clavicle Locking Hook Plate	4×64×L	
957-357-25006	957-257-25006		6×84×L	
957-357-25104	957-257-25104		4×64×R	
957-357-25106	957-257-25106		6×84×R	
957-357-26006	957-257-26006	Clavicle Locking Reconstruction Plate	11×6×68×L	
957-357-26106	957-257-26106		11×6×68×R	
957-357-26008	957-257-26008		11×8×92×L	
957-357-26108	957-257-26108		11×8×92×R	
957-357-26007	957-257-26007		11×7	
		Femur		
957-357-27003	957-257-27003	5.0mm LCP Proximal Femur Plate	3×124	
957-357-27004	957-257-27004		4×140	
957-357-27005	957-257-27005		5×156	
957-357-27006	957-257-27006		6×172	
957-357-27008	957-257-27008		8×204	
957-357-27010	957-257-27010		10×236	
957-357-27012	957-257-27012		12×268	
934-334-07065	934-234-07065		7.0mm DIA. Lag Screw for LCP-Proximal Femur Plate	
934-334-07070	934-234-07070	7.0×70		
934-334-07075	934-234-07075	7.0×75		
934-334-07080	934-234-07080	7.0×80		
934-334-07085	934-234-07085	7.0×85		
934-334-07090	934-234-07090	7.0×90		
934-334-07095	934-234-07095	7.0×95		
934-334-07100	934-234-07100	7.0×100		
934-334-07105	934-234-07105	7.0×105		
934-334-07110	934-234-07110	7.0×110		
951-351-17006	951-251-17006	5.0mm LCP Limited Contact Femur Plate	6×18×108	
951-351-17007	951-251-17007		7×18×126	
951-351-17008	951-251-17008		8×18×144	
951-351-17009	951-251-17009		9×18×162	
951-351-17010	951-251-17010		10×18×180	
951-351-17011	951-251-17011		11×18×198	
951-351-17012	951-251-17012		12×18×216	
951-351-17013	951-251-17013		13×18×234	
951-351-17014	951-251-17014		14×18×252	
951-351-17015	951-251-17015		15×18×270	







BIOTECH

957-357-06105	957-257-06105	5.0mm LCP Distal Femoral Condylar Buttress Plate	5×18×158×L	
957-357-06205	957-257-06205		5×18×158×R	
957-357-06107	957-257-06107		7×18×198×L	
957-357-06207	957-257-06207		7×18×198×R	
957-357-06109	957-257-06109		9×18×238×L	
957-357-06209	957-257-06209		9×18×238×R	
957-357-06111	957-257-06111		11×18×278×L	
957-357-06211	957-257-06211		11×18×278×R	
Tibia				
957-357-07105	957-257-07105	5.0mm LCP Lateral Tibial Head Buttress Plate	5×18×144×L	
957-357-07205	957-257-07205		5×18×144×R	
957-357-07107	957-257-07107		7×18×184×L	
957-357-07207	957-257-07207		7×18×184×R	
957-357-07109	957-257-07109		9×18×224×L	
957-357-07209	957-257-07209		9×18×224×R	
957-357-07111	957-257-07111		11×18×264×R	
957-357-07211	957-257-07211		11×18×264×R	
957-357-11004	957-257-11004	5.0mm LCP T Buttress Plate For fractures in medial tibial plateau	4×86	
957-357-11005	957-257-11005		5×102	
957-357-11006	957-257-11006		6×118	
957-357-28003	957-257-28003	5.0mm LCP L Buttress Plate	3×72×L	
957-357-28103	957-257-28103		3×72×R	
957-357-28004	957-257-28004		4×88×L	
957-357-28104	957-257-28104		4×88×R	
957-357-28005	957-257-28005		5×104×L	
957-357-28105	957-257-28105		5×104×R	
957-357-28006	957-257-28006		6×120×L	
957-357-28106	957-257-28106		6×120×R	
957-357-30035	957-257-30035	3.5/5.0mm LCP Limited Contact Tibial Metaphysis Plate	3+5holes×14width×118length	
957-357-30045	957-257-30045		4+5 holes×14width×136 length	
957-357-30055	957-257-30055		5+5 holes×14width×154 length	
957-357-30065	957-257-30065		6+5 holes×14width×172 length	
957-357-30075	957-257-30075		7+5 holes×14width×190 length	
957-357-30085	957-257-30085		8+5 holes×14width×208 length	
957-357-30095	957-257-30095		9+5 holes×14width×226 length	
957-357-30115	957-257-30115		11+5 holes×14width×262 length	
957-357-30135	957-257-30135		13+5 holes×14width×298 length	
951-351-12004	951-251-12004	5.0mm LCP Limited Contact Tibia / Humerus Plate	4×14×72	
951-351-12005	951-251-12005		5×14×90	
951-351-12006	951-251-12006		6×14×108	
951-351-12007	951-251-12007		7×14×126	
951-351-12008	951-251-12008		8×14×144	
951-351-12009	951-251-12009		9×14×162	
951-351-12010	951-251-12010		10×14×180	
951-351-12011	951-251-12011		11×14×198	
951-351-12012	951-251-12012		12×14×216	
951-351-12013	951-251-12013		13×14×234	
951-351-12014	951-251-12014		14×14×252	

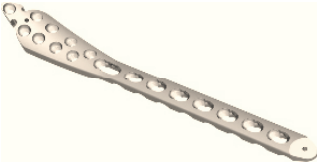



BIOTECH

957-357-31004	957-257-31004	3.5mm LCP Medial Distal Tibial Condylar Plate	4×118×L	
957-357-31104	957-257-31104		4×118×R	
957-357-31006	957-257-31006		6×144×L	
957-357-31106	957-257-31106		6×144×R	
957-357-31008	957-257-31008		8×170×L	
957-357-31108	957-257-31108		8×170×R	
957-357-31010	957-257-31010		10×196×L	
957-357-31110	957-257-31110		10×196×R	
957-357-07107	957-257-07107	3.5mm LCP Lateral Distal Tibial Condylar Plate	7×122×L	
957-357-07207	957-257-07207		7×122×R	
957-357-07109	957-257-07109		9×158×L	
957-357-07209	957-257-07209		9×158×R	
957-357-07111	957-257-07111		11×194×L	
957-357-07211	957-257-07211		11×194×R	
957-357-07113	957-257-07113		13×230×L	
957-357-07213	957-257-07213		13×230×R	
Calcaneus				
957-357-32060	957-257-32060	Calcaneal Locking Plate	14×60×L	
957-357-32070	957-257-32070		14×70×L	
957-357-32160	957-257-32160		14×60×R	
957-357-32170	957-257-32170		14×70×R	
Pelvis & Acetabulum				
956-356-10005	956-256-10005	3.5mm LCP Reconstruction Plate	5×10×58	
956-356-10006	956-256-10006		6×10×70	
956-356-10007	956-256-10007		7×10×82	
956-356-10008	956-256-10008		8×10×94	
956-356-10009	956-256-10009		9×10×106	
956-356-10010	956-256-10010		10×10×118	
956-356-10012	956-256-10012		12×10×142	
956-356-10014	956-256-10014		14×10×166	
956-356-12004	956-256-12004	5.0mm LCP Reconstruction Plate	4×12×76	
956-356-12005	956-256-12005		5×12×94	
956-356-12006	956-256-12006		6×12×114	
956-356-12007	956-256-12007		7×12×132	
956-356-12008	956-256-12008		8×12×152	
956-356-12009	956-256-12009		9×12×170	
956-356-12010	956-256-12010		10×12×190	
956-356-12011	956-256-12011		11×12×208	



BIOTECH

		Locking Screws		
908-308-35010	908-208-35010	3.5mm DIA. Locking Screw	3.5x10	
908-308-35012	908-208-35012		3.5x12	
908-308-35014	908-208-35014		3.5x14	
908-308-35016	908-208-35016		3.5x16	
908-308-35018	908-208-35018		3.5x18	
908-308-35020	908-208-35020		3.5x20	
908-308-35022	908-208-35022		3.5x22	
908-308-35024	908-208-35024		3.5x24	
908-308-35026	908-208-35026		3.5x26	
908-308-35028	908-208-35028		3.5x28	
908-308-35030	908-208-35030		3.5x30	
908-308-35032	908-208-35032		3.5x32	
908-308-35034	908-208-35034		3.5x34	
908-308-35036	908-208-35036		3.5x36	
908-308-35038	908-208-35038		3.5x38	
908-308-35040	908-208-35040		3.5x40	
908-308-35045	908-208-35045		3.5x45	
908-308-35050	908-208-35050		3.5x50	
908-308-35055	908-208-35055		3.5x55	
908-308-35060	908-208-35060		3.5x60	
908-308-05014	908-208-05014	5.0mm DIA. Locking Screw	5x14	
908-308-05018	908-208-05018		5x18	
908-308-05022	908-208-05022		5x22	
908-308-05024	908-208-05024		5x24	
908-308-05026	908-208-05026		5x26	
908-308-05030	908-208-05030		5x30	
908-308-05032	908-208-05032		5x32	
908-308-05034	908-208-05034		5x34	
908-308-05036	908-208-05036		5x36	
908-308-05038	908-208-05038		5x38	
908-308-05040	908-208-05040		5x40	
908-308-05042	908-208-05042		5x42	
908-308-05044	908-208-05044		5x44	
908-308-05046	908-208-05046		5x46	
908-308-05048	908-208-05048		5x48	
908-308-05050	908-208-05050		5x50	
908-308-05055	908-208-05055		5x55	
908-308-05060	908-208-05060		5x60	
908-308-05065	908-208-05065		5x65	
908-308-05070	908-208-05070		5x70	
908-308-05075	908-208-05075	5x75		
908-308-05080	908-208-05080	5x80		
908-308-05085	908-208-05085	5x85		
908-308-05090	908-208-05090	5x90		

Instruments

Instruments for Locking Compression Plates				
No.	Instruments description	Specifications	Quantity/set	
1	Guide pin	Φ1.5x150	5	
2	Guide pin sleeve	Φ1.5	2	
3	Sleeve wrench	Φ4.5	1	
4	Drill bit	Φ2.8	2	
5	Drill stop	Φ2.8	2	
6	Drill sleeve	Φ2.8	2	
7	Reduction drill	Φ2.8	1	
8	Tap	3,5	1	
9	Screwdriver	W2,5	1	
10	Torque wrench handle	Φ5.5/1.5N.M	1	
11	Torque wrench shaft	Φ2.5/Φ5.5	2	
12	Compression drill sleeve	Φ2.5	1	
13	Drill stop wrench	W2,5	1	
14	Quick-release T-handle (Triangle)	Φ5.5	1	
15	Screw box		1	
16	Instruments box		1	



BIOTECH

III. Pins, wires, staples

1. Bundle Pins
2. Steinmann Pin
3. Kirschner wires
4. Cerclage wires
5. Knowles Pin
6. Rush Nail
7. Bone staples
8. Gigli saws

Bundle pins

Round type		
L mm	b mm	cat. no.
200	2	973-373-02200
260	2	973-373-02260
370	3	973-373-03300
400	3	973-373-03400
500	3	973-373-03500
600	3	973-373-03600

With flattened end		
L mm	L=300 mm	L=350 mm
1,2	974-374-12300	
1,5	974-374-15300	
1,8	974-374-18300	
2,0	974-374-20300	
2,2	974-374-22300	974-374-22350
2,5	974-374-25300	974-374-25350
3,0	974-374-30300	974-374-30350



Steinmann Pin

D	L	STEEL
3,5	120	986-386-35120
3,5	150	986-386-35150
3,5	200	986-386-35200
3,5	250	986-386-35250
3,5	300	986-386-35300
4,0	120	986-386-40120
4,0	150	986-386-40150
4,0	200	986-386-40200
4,0	250	986-386-40250
4,0	300	986-386-40300
4,5	120	986-386-45120
4,5	150	986-386-45150
4,5	200	986-386-45200
4,5	250	986-386-45250
4,5	300	986-386-45300
5,0	150	986-386-50150
5,0	200	986-386-50200
5,0	250	986-386-50250
5,0	300	986-386-50300

THREADED		
D	L	STEEL
3,0	120	988-388-30120
3,0	150	988-388-30150
3,0	200	988-388-30200
3,0	250	988-388-30250
3,0	300	988-388-30300
3,5	120	988-388-35120
3,5	150	988-388-35150
3,5	200	988-388-35200
3,5	250	988-388-35250
3,5	300	988-388-35300
4,0	120	988-388-40120
4,0	150	988-388-40150
4,0	200	988-388-40200
4,0	250	988-388-40250
4,0	300	988-388-40300
4,5	120	988-388-45120
4,5	150	988-388-45150
4,5	200	988-388-45200
4,5	250	988-388-45250
4,5	300	988-388-45300
5,0	150	988-388-50150
5,0	200	988-388-50200
5,0	250	988-388-50250
5,0	300	988-388-50300



Kirschner boring wire

D mm	L = 70 mm	L = 80 mm	L = 120 mm
0.8	975-375-08070	975-375-08080	975-375-08120
1		975-375-10080	975-375-10120
1.2			975-375-12120
1.4			975-375-14120
1.5			975-375-15120

D mm	L = 150 mm	L = 200 mm	L = 250 mm
0.8	975-375-08150		
1	975-375-10150		
1.2	975-375-12150		
1.4	975-375-14150		
1.5	975-375-15150		
1.6	975-375-16150		
1.8	975-375-18150		
2	975-375-20150	975-375-20200	975-375-20250
2.2	975-375-22150		
2.5	975-375-25150		
3	975-375-30150	975-375-30200	

D mm	L = 280 mm	L = 300 mm	L = 500 mm
0.8		975-375-08300	
1		975-375-10300	
1.2		975-375-12300	
1.4		975-375-14300	
1.5		975-375-15300	
1.6		975-375-16300	
1.8		975-375-18300	937518500
2		975-375-20300	937520500
2.2		975-375-22300	937522500
2.5		975-375-25300	937525500
2.7	975-375-27280		
3		975-375-30300	937530500



Kirschner boring wire

D mm	L = 80 mm	L = 120 mm	L = 150 mm
0.8	976-376-08080	976-376-08120	976-376-08150
1	976-376-10080	976-376-10120	976-376-10150
1.2		976-376-12120	976-376-12150
1.4		976-376-14120	976-376-14150
1.5		976-376-15120	976-376-15150
1.6			976-376-162150
1.8			976-376-18150
2			976-376-20150
2.2			976-376-22150
2.5			976-376-25150
3			976-376-30150

D mm	L = 200 mm	L = 300 mm
0.8	976-376-08200	976-376-08300
1	976-376-10200	976-376-10300
1.2	976-376-12200	976-376-12300
1.4	976-376-14200	976-376-14300
1.5	976-376-15200	976-376-15300
1.6	976-376-16200	976-376-16300
1.8	976-376-18200	976-376-18300
2	976-376-20200	976-376-20300
2.2	976-376-22200	976-376-22300
2.5	976-376-25200	976-376-25300
3	976-376-30200	976-376-30300



Special kirschner boring wire

Threaded		
D mm	L mm	STEEL
1,0	310	979-379-10310
1,2	310	979-379-12310
1,4	310	979-379-14310
1,5	150	978-379-15150
1,5	150	979-379-15150
1,5	310	979-379-15310
1,6	310	979-379-16310
1,8	100	979-379-18100
1,8	310	979-379-18310
2,0	100	979-379-20100
2,0	150	979-379-20150
2,0	250	978-379-20250
2,0	310	979-379-20310
2,2	310	979-379-22310
2,5	100	979-379-25100
2,5	150	978-379-25150
2,5	200	979-379-25200
2,5	230	979-379-25230
2,5	310	979-379-25310
2,5	350	978-379-25350
3,0	310	979-379-30310

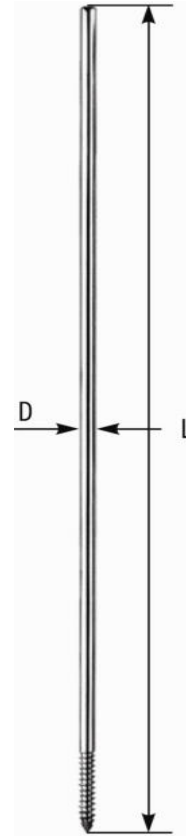

Cerclage wire

D	L	STEEL
0,2	10 m	985-385-02010
0,5	10 m	985-385-05010
0,6	10 m	985-385-06010
0,8	10 m	985-385-08010
1,0	10 m	985-385-10010
1,2	10 m	985-385-12010
1,4	10 m	985-385-14010



Knowles Pin

D mm	L mm	cat.no.
4	57	982-382-04057
4	63	982-382-04063
4	70	982-382-04070
4	76	982-382-04076
4	82	982-382-04082
4	89	982-382-04089
4	95	982-382-04095
4	102	982-382-04102
4	108	982-382-04108
4	114	982-382-04114
4	121	982-382-04121
4	127	982-382-04127



Bone Staples















step mm	size mm	cat.no.
5	28x33	986-386-03305
10	28x38	986-386-03810
15	28x43	986-386-04315



Gigli saw

L	STEEL
40 cm	630-330-00400
50 cm	630-330-0500



UNIVERSAL SCREWS, NUTS, WASHERS	
Washer d=13 mm for large cancellous bone screws	
STEEL 929-329-99001 TITAN 929-229-99001	
Washer d=7 mm for small cancellous bone screws	
STEEL 929-329-99002 TITAN 929-229-99002	
Washer d=4,2 mm for mini screws (d=1,5 and d=2 mm)	
STEEL 929-329-99003 TITAN 929-229-99003	
Washer for fastening wires	
STEEL 929-329-99004 TITAN 929-329-99004	
Metal button for tendon stitches	
STEEL 929-329-99005 TITAN 929-229-99005	
Metal button for tendon stitches	
STEEL 929-329-99006 TITAN 929-229-99006	
for 4 mm diameter cancellous bone screws	
STEEL 929-329-99007 TITAN 929-229-99007	
Spiked washer with 3,5 mm diameter hole	
STEEL 929-329-99008 TITAN 929-229-99008	
Spiked washer with 4,5 mm diameter hole	
STEEL 929-329-99009 TITAN 929-229-99009	
Double-holed spiked washer with 4 mm diameter holes	
STEEL 929-329-99010 TITAN 929-229-99010	
Cortical nut d=4,5 mm	
STEEL 929-329-99011 TITAN 929-229-99011	
Washer for ligament d=13 / d=6 mm	
STEEL 929-329-99012 TITAN 929-229-99012	
Washer for ligament d=13 / d=4,2mm	
STEEL 929-329-99013 TITAN 929-229-99013	
Washer for ligament Size: d=8 / d=3,2 mm	
STEEL 929-329-99014 TITAN 929-229-99014	



IV. Femoral Neck Screw fixation

1. Femoral neck screws
2. Support plate for femoral neck screw
3. Instrumentation set for femoral neck screw fixation

Femoral neck screw

d=9,5 mm l ₁ = 25 mm		
L mm	TITAN	STEEL
75	930-230-25075	930-330-25075
80	930-230-25080	930-330-25080
85	930-230-25085	930-330-25085
90	930-230-25090	930-330-25090
95	930-230-25095	930-330-25095
100	930-230-25100	930-330-25100
105	930-230-25105	930-330-25105
110	930-230-25110	930-330-25110
115	930-230-25115	930-330-25115
120	930-230-25120	930-330-25120
125	930-230-25125	930-330-25125
130	930-230-25130	930-330-25130
135	930-230-25135	930-330-25135
140	930-230-25140	930-330-25140
145	930-230-25145	930-330-25145

d=8 mm l ₁ =18 mm		
L mm	TITAN	STEEL
75	931-231-18075	931-331-18075
80	931-231-18080	931-331-18080
85	931-231-18085	931-331-18085
90	931-231-18090	931-331-18090
95	931-231-18095	931-331-18095
100	931-231-18100	931-331-18100
105	931-231-18105	931-331-18105
110	931-231-18110	931-331-18110
115	931-231-18115	931-331-18115
120	931-231-18120	931-331-18120
125	931-231-18125	931-331-18125
130	931-231-18130	931-331-18130
135	931-231-18135	931-331-18135
140	931-231-18140	931-331-18140
145	931-231-18145	931-331-18145



Femoral neck screw

d=8 mm l ₁ = 25 mm		
L mm	TITAN	STEEL
75	931-231-25075	931-331-25075
80	931-231-25080	931-331-25080
85	931-231-25085	931-331-25085
90	931-231-25090	931-331-25090
95	931-231-25095	931-331-25095
100	931-231-25100	931-331-25100
105	931-231-25105	931-331-25105
110	931-231-25110	931-331-25110
115	931-231-25115	931-331-25115
120	931-231-25120	931-331-25120
125	931-231-25125	931-331-25125
130	931-231-25130	931-331-25130
135	931-231-25135	931-331-25135
140	931-231-25140	931-331-25140
145	931-231-25145	931-331-25145
150	931-231-25150	

d=8 mm l ₁ =34 mm		
L mm	TITAN	STEEL
75	931-231-34075	931-331-34075
80	931-231-34080	931-331-34080
85	931-231-34085	931-331-34085
90	931-231-34090	931-331-34090
95	931-231-34095	931-331-34095
100	931-231-34100	931-331-34100
105	931-231-34105	931-331-34105
110	931-231-34110	931-331-34110
115	931-231-34115	931-331-34115
120	931-231-34120	931-331-34120
125	931-231-34125	931-331-34125
130	931-231-34130	931-331-34130
135	931-231-34135	931-331-34135
140	931-231-34140	931-331-34140
145	931-231-34145	931-331-34145



Support plate for femoral neck screw

no. of holes	TITAN	STEEL
1+1	959-259-04002	959-359-04002



INSTRUMENTATION SET FOR FEMORAL NECK SCREW FIXATION

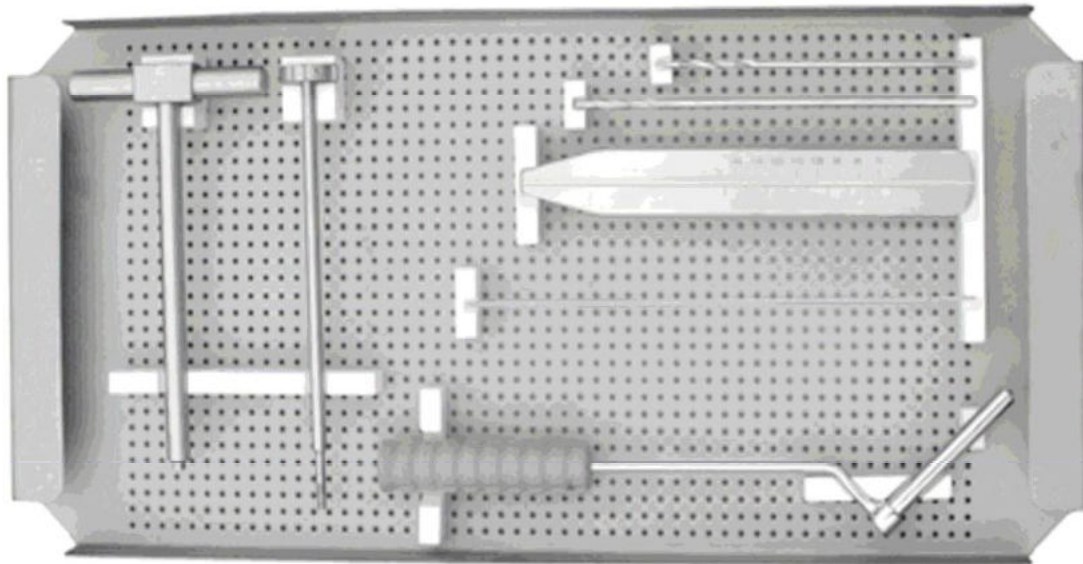

Biotech code	description	pcs/set
699-399-99030	Wrench with T-Handle	1
699-399-99031	Threaded retaining stem	1
699-399-99035	Linear gauge for screw	1
675-375-20250	Kirschner boring wire 2x250 mm	4
699-399-99041	Free hand device	1
699-399-99033	Spiral drill, cannulated 4,5/2,2 x 195 mm	1
699-001-70009	tray empty	1
699-001-70109	tray complete	1
699-001-50009	container empty	1
699-001-50109	container complete	1



V. Dynamic screw fixation

1. Dynamic screws
2. Compression screw
3. Barrel plates
4. Instrumentation set for Dynamic Screw fixation

Dynamic screw fixation for trochanteric and condyle fractures

Dynamic screw for supporting plate with self-cutting thread

L mm	cat. no.
50	934-334-08050
55	934-334-08055
60	934-334-08060
65	934-334-08065
70	934-334-08070
75	934-334-08075
80	934-334-08080
85	934-334-08085
90	934-334-08090
95	934-334-08095
100	934-334-08100
105	934-334-08105
110	934-334-08110
115	934-334-08115
120	934-334-08120
125	934-334-08125
130	934-334-08130
135	934-334-08135
140	934-334-08140
145	934-334-08145



Compression screw

L mm	cat. no.
15	932-332-00015
28	932-332-00028



Dynamic screw fixation for trochanteric and condyle fractures

Barrel plate

no. of holes	125°	130°	135°
2	935-335-02125	935-335-02130	935-335-02135
3	935-335-03125	935-335-03130	935-335-03135
4	935-335-04125	935-335-04130	935-335-04135
5	935-335-05125	935-335-05130	935-335-05135
6	935-335-06125	935-335-06130	935-335-06135
7	935-335-07125	935-335-07130	935-335-07135
8	935-335-08125	935-335-08130	935-335-08135
10	935-335-10125	935-335-10130	935-335-10135
12	935-335-12125	935-335-12130	935-335-12135
14	935-335-14125	935-335-14130	935-335-14135
16	935-335-16125	935-335-16130	935-335-16135

no. of holes	140°	145°	150°
2	935-335-02140	935-335-02145	935-335-02150
3	935-335-03140	935-335-03145	935-335-03150
4	935-335-04140	935-335-04145	935-335-04150
5	935-335-05140	935-335-05145	935-335-05150
6	935-335-06140	935-335-06145	935-335-06150
7	935-335-07140	935-335-07145	935-335-07150
8	935-335-08140	935-335-08145	935-335-08150
10	935-335-10140	935-335-10145	935-335-10150
12	935-335-12140	935-335-12145	935-335-12150
14	935-335-14140	935-335-14145	935-335-14150
16	935-335-16140	935-335-16145	935-335-16150

no. of holes	95°
4	935-335-04095
5	935-335-05095
6	935-335-06095
7	935-335-07095
8	935-335-08095
10	935-335-10095
12	935-335-12095
14	935-335-14095
16	935-335-16095
18	935-335-18095
20	935-335-20095
22	935-335-22095



Trochanteric plate

STEEL
939-339-0000

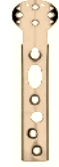

INSTRUMENTATION SET FOR DYNAMIC SCREW FIXATION

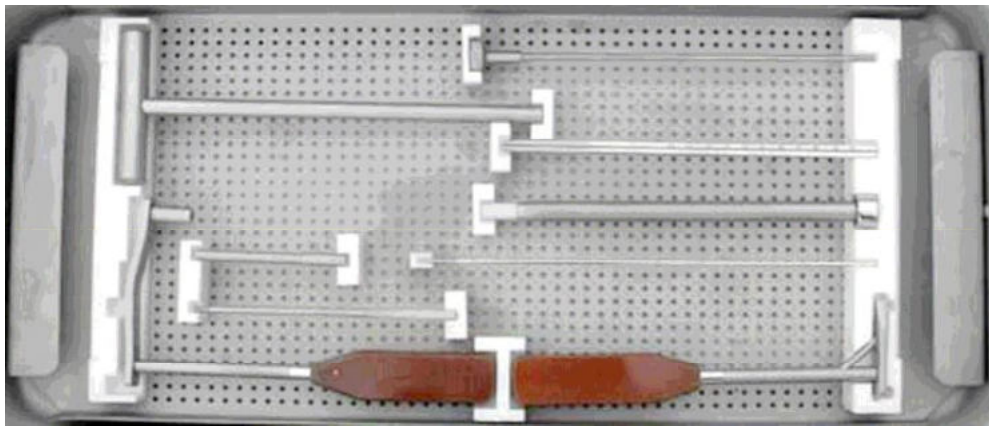
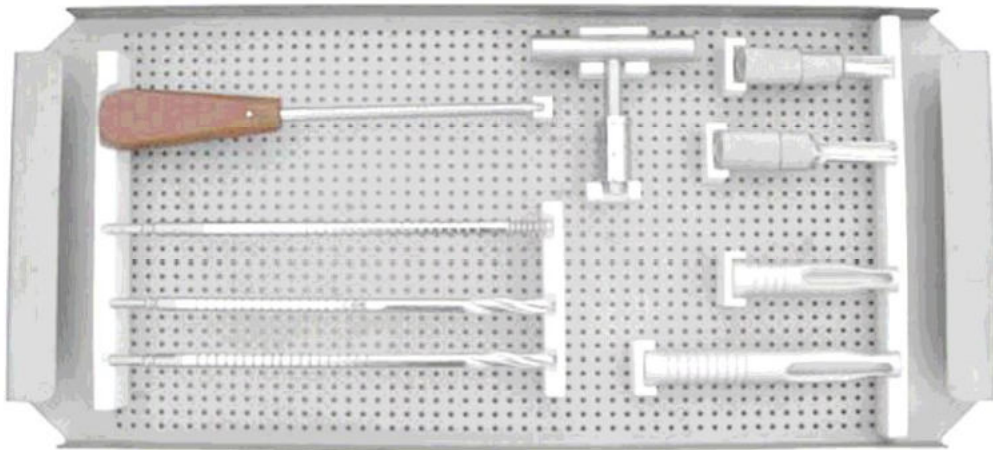

Biotech code	description	pcs/set
629-229-00001	Target device	1
629-229-00002	rotating wrench	1
629-229-00003	three-cornered drill	1
629-229-00004	reamer-bit	1
629-229-00005	nut for reamer-bit	1
629-229-00006	plate guide	1
675-375-20250	Kirscher 2,5x250mm	3
629-229-00008	depth gauge	1
629-229-00009	threaded retaining stem	1
629-229-00010	tap drill	1
629-229-00011	long rotating wrench	1
629-229-00012	plate impactor	1
629-229-00013	screw lengthening wrench	1
629-229-00014	screwdriver w. handle (3,5mm)	1
629-001-70010	tray empty	1
629-001-70110	tray complete	1
629-001-50010	container empty	1
629-001-50110	container complete	1



BIOTECH

VI. Intra-medullary Nails

1. Biotech Humeral Nails
2. Biotech Tibial Nails
3. BLF - Biotech Long Femoral Nails Anterograd/Retrograd
4. BSF - Biotech Short Femoral Nails Anterograd/Retrograd
5. BSP - Biotech Short Pertrochanter Nails
6. BLP - Biotech Long Pertrochanter Nails
7. Titanium Elastic Nail
8. Rush Nail
9. Intra-medullary nailing instrument sets

Biotech Humeral Nail

d= 7mm with guiding bore

L mm	ANODISED TITAN	TITAN	STEEL
180	998-198-07180	998-298-07180	998-398-07180
200	998-198-07200	998-298-07200	998-398-07200
220	998-198-07220	998-298-07220	998-398-07220
240	998-198-07240	998-298-07240	998-398-07240
260	998-198-07260	998-298-07260	998-398-07260
280	998-198-07280	998-298-07280	998-398-07280

d= 8mm with guiding bore

L mm	ANODISED TITAN	TITAN	STEEL
180	998-198-08180	998-298-08180	998-398-08180
200	998-198-08200	998-298-08200	998-398-08200
220	998-198-08220	998-298-08220	998-398-08220
240	998-198-08240	998-298-08240	998-398-08240
260	998-198-08260	998-298-08260	998-398-08260
280	998-198-08280	998-298-08280	998-398-08280

d= 9mm with guiding bore

L mm	ANODISED TITAN	TITAN	STEEL
180	998-198-09180	998-198-09180	998-398-09180
200	998-198-09200	998-198-09200	998-398-09200
220	998-198-09220	998-198-09220	998-398-09220
240	998-198-09240	998-198-09240	998-398-09240
260	998-198-09260	998-198-09260	998-398-09260
280	998-198-09280	998-198-09280	998-398-09280



BIOTECH Humeral Nail

d= 7 mm, solid			
L mm	ANODISED TITAN	TITAN	STEEL
180	995-195-07180	995-295-07180	995-395-07180
200	995-195-07200	995-295-07200	995-395-07200
220	995-195-07220	995-295-07220	995-395-07220
240	995-195-07240	995-295-07240	995-395-07240
260	995-195-07260	995-295-07260	995-395-07260
280	995-195-07280	995-295-07280	995-395-07280
300	995-195-07300	995-295-07300	995-395-07300

d= 8 mm, solid			
L mm	ANODISED TITAN	TITAN	STEEL
180	995-195-08180	995-295-08180	995-395-08180
200	995-195-08200	995-295-08200	995-395-08200
220	995-195-08220	995-295-08220	995-395-08220
240	995-195-08240	995-295-08240	995-395-08240
260	995-195-08260	995-295-08260	995-395-08260
280	995-195-08280	995-295-08280	995-395-08280
300	995-195-08300	995-295-08300	995-395-08300

d= 9 mm, solid			
L mm	ANODISED TITAN	TITAN	STEEL
180	995-195-09180	995-295-09180	995-395-09180
200	995-195-09200	995-295-09200	995-395-09200
220	995-195-09220	995-295-09220	995-395-09220
240	995-195-09240	995-295-09240	995-395-09240
260	995-195-09260	995-295-09260	995-395-09260
280	995-195-09280	995-295-09280	995-395-09280
300	995-195-09300	995-295-09300	995-395-09300



BIOTECH Tibial Nail

d= 8mm with guiding bore

L mm	ANODISED TITAN	TITAN	STEEL
255	997-197-08255	997-297-08255	997-397-08255
270	997-197-08270	997-297-08270	997-397-08270
285	997-197-08285	997-297-08285	997-397-08285
300	997-197-08300	997-297-08300	997-397-08300
315	997-197-08315	997-297-08315	997-397-08315
330	997-197-08330	997-297-08330	997-397-08330
345	997-197-08345	997-297-08345	997-397-08345
360	997-197-08360	997-297-08360	997-397-08360
375	997-197-08375	997-297-08375	997-397-08375
390	997-197-08390	997-297-08390	997-397-08390
405	997-197-08405	997-297-08405	997-397-08405
420	997-197-08420	997-297-08420	997-397-08420

d= 8mm solid

L mm	ANODISED TITAN	TITAN	STEEL
255	999-199-08255	999-299-08255	999-399-08255
270	999-199-08270	999-299-08270	999-399-08270
285	999-199-08285	999-299-08285	999-399-08285
300	999-199-08300	999-299-08300	999-399-08300
315	999-199-08315	999-299-08315	999-399-08315
330	999-199-08330	999-299-08330	999-399-08330
345	999-199-08345	999-299-08345	999-399-08345
360	999-199-08360	999-299-08360	999-399-08360
375	999-199-08375	999-299-08375	999-399-08375
390	999-199-08390	999-299-08390	999-399-08390
405	999-199-08405	999-299-08405	999-399-08405
420	999-199-08420	999-299-08420	999-399-08420

d= 9mm with guiding bore

L mm	ANODISED TITAN	TITAN	STEEL
255	997-197-09255	997-297-09255	997-397-09255
270	997-197-09270	997-297-09270	997-397-09270
285	997-197-09285	997-297-09285	997-397-09285
300	997-197-09300	997-297-09300	997-397-09300
315	997-197-09315	997-297-09315	997-397-09315
330	997-197-09330	997-297-09330	997-397-09330
345	997-197-09345	997-297-09345	997-397-09345
360	997-197-09360	997-297-09360	997-397-09360
375	997-197-09375	997-297-09375	997-397-09375
390	997-197-09390	997-297-09390	997-397-09390
405	997-197-09405	997-297-09405	997-397-09405
420	997-197-09420	997-297-09420	997-397-09420



BIOTECH Tibial Nail

d= 9mm solid

L mm	ANODISED TITAN	TITAN	STEEL
255	999-199-09255	999-299-09255	999-399-09255
270	999-199-09270	999-299-09270	999-399-09270
285	999-199-09285	999-299-09285	999-399-09285
300	999-199-09300	999-299-09300	999-399-09300
315	999-199-09315	999-299-09315	999-399-09315
330	999-199-09330	999-299-09330	999-399-09330
345	999-199-09345	999-299-09345	999-399-09345
360	999-199-09360	999-299-09360	999-399-09360
375	999-199-09375	999-299-09375	999-399-09375
390	999-199-09390	999-299-09390	999-399-09390
405	999-199-09405	999-299-09405	999-399-09405
420	999-199-09420	999-299-09420	999-399-09420

d= 10mm with guiding bore

L mm	ANODISED TITAN	TITAN	STEEL
255	997-197-10255	997-297-10255	997-397-10255
270	997-197-10270	997-297-10270	997-397-10270
285	997-197-10285	997-297-10285	997-397-10285
300	997-197-10300	997-297-10300	997-397-10300
315	997-197-10315	997-297-10315	997-397-10315
330	997-197-10330	997-297-10330	997-397-10330
345	997-197-10345	997-297-10345	997-397-10345
360	997-197-10360	997-297-10360	997-397-10360
375	997-197-10375	997-297-10375	997-397-10375
390	997-197-10390	997-297-10390	997-397-10390
405	997-197-10405	997-297-10405	997-397-10405
420	997-197-10420	997-297-10420	997-397-10420

d= 10mm solid

L mm	ANODISED TITAN	TITAN	STEEL
255	999-199-10255	999-299-10255	999-399-10255
270	999-199-10270	999-299-10270	999-399-10270
285	999-199-10285	999-299-10285	999-399-10285
300	999-199-10300	999-299-10300	999-399-10300
315	999-199-10315	999-299-10315	999-399-10315
330	999-199-10330	999-299-10330	999-399-10330
345	999-199-10345	999-299-10345	999-399-10345
360	999-199-10360	999-299-10360	999-399-10360
375	999-199-10375	999-299-10375	999-399-10375
390	999-199-10390	999-299-10390	999-399-10390
405	999-199-10405	999-299-10405	999-399-10405
420	999-199-10420	999-299-10420	999-399-10420



BIOTECH Tibial Nail

d= 11mm			
L mm	ANODISED TITAN	TITAN	STEEL
255	997-197-11255	997-297-11255	997-397-11255
270	997-197-11270	997-297-11270	997-397-11270
285	997-197-11285	997-297-11285	997-397-11285
300	997-197-11300	997-297-11300	997-397-11300
315	997-197-11315	997-297-11315	997-397-11315
330	997-197-11330	997-297-11330	997-397-11330
345	997-197-11345	997-297-11345	997-397-11345
360	997-197-11360	997-297-11360	997-397-11360
375	997-197-11375	997-297-11375	997-397-11375
390	997-197-11390	997-297-11390	997-397-11390
405	997-197-11405	997-297-11405	997-397-11405
420	997-197-11420	997-297-11420	997-397-11420
435	997-197-11435	997-297-11435	997-397-11435

d= 12mm			
L mm	ANODISED TITAN	TITAN	STEEL
255	997-197-12255	997-297-12255	997-397-12255
270	997-197-12270	997-297-12270	997-397-12270
285	997-197-12285	997-297-12285	997-397-12285
300	997-197-12300	997-297-12300	997-397-12300
315	997-197-12315	997-297-12315	997-397-12315
330	997-197-12330	997-297-12330	997-397-12330
345	997-197-12345	997-297-12345	997-397-12345
360	997-197-12360	997-297-12360	997-397-12360
375	997-197-12375	997-297-12375	997-397-12375
390	997-197-12390	997-297-12390	997-397-12390
405	997-197-12405	997-297-12405	997-397-12405
420	997-197-12420	997-297-12420	997-397-12420
435	997-197-12435	997-297-12435	997-397-12435

d= 13mm			
L mm	ANODISED TITAN	TITAN	STEEL
255	997-197-13255	997-297-13255	997-397-13255
270	997-197-13270	997-297-13270	997-397-13270
285	997-197-13285	997-297-13285	997-397-13285
300	997-197-13300	997-297-13300	997-397-13300
315	997-197-13315	997-297-13315	997-397-13315
330	997-197-13330	997-297-13330	997-397-13330
345	997-197-13345	997-297-13345	997-397-13345
360	997-197-13360	997-297-13360	997-397-13360
375	997-197-13375	997-297-13375	997-397-13375
390	997-197-13390	997-297-13390	997-397-13390
405	997-197-13405	997-297-13405	997-397-13405
420	997-197-13420	997-297-13420	997-397-13420
435	997-197-13435	997-297-13435	997-397-13435



BIOTECH Tibial Nail

d= 14mm			
L mm	ANODISED TITAN	TITAN	STEEL
255	997-197-14255	997-297-14255	997-397-14255
270	997-197-14270	997-297-14270	997-397-14270
285	997-197-14285	997-297-14285	997-397-14285
300	997-197-14300	997-297-14300	997-397-14300
315	997-197-14315	997-297-14315	997-397-14315
330	997-197-14330	997-297-14330	997-397-14330
345	997-197-14345	997-297-14345	997-397-14345
360	997-197-14360	997-297-14360	997-397-14360
375	997-197-14375	997-297-14375	997-397-14375
390	997-197-14390	997-297-14390	997-397-14390
405	997-197-14405	997-297-14405	997-397-14405
420	997-197-14420	997-297-14420	997-397-14420
435	997-197-14435	997-297-14435	997-397-14435



BLF Nail - Biotech Long Anterograd/Retrograd Femoral Nail SOLID

d= 9mm solid			
L mm	ANODISED TITAN	TITAN	STEEL
300	993-193-09300	993-293-09300	993-393-09300
320	993-193-09320	993-293-09320	993-393-09320
340	993-193-09340	993-293-09340	993-393-09340
360	993-193-09360	993-293-09360	993-393-09360
380	993-193-09380	993-293-09380	993-393-09380
400	993-193-09400	993-293-09400	993-393-09400
420	993-193-09420	993-293-09420	993-393-09420
440	993-193-09440	993-293-09440	993-393-09440
460	993-193-09460	993-293-09460	993-393-09460
480	993-193-09480	993-293-09480	993-393-09480

d= 10mm solid			
L mm	ANODISED TITAN	TITAN	STEEL
300	993-193-10300	993-293-10300	993-393-10300
320	993-193-10320	993-293-10320	993-393-10320
340	993-193-10340	993-293-10340	993-393-10340
360	993-193-10360	993-293-10360	993-393-10360
380	993-193-10380	993-293-10380	993-393-10380
400	993-193-10400	993-293-10400	993-393-10400
420	993-193-10420	993-293-10420	993-393-10420
440	993-193-10440	993-293-10440	993-393-10440
460	993-193-10460	993-293-10460	993-393-10460
480	993-193-10480	993-293-10480	993-393-10480

d= 11mm solid			
L mm	ANODISED TITAN	TITAN	STEEL
300	993-193-11300	993-293-11300	993-393-11300
320	993-193-11320	993-293-11320	993-393-11320
340	993-193-11340	993-293-11340	993-393-11340
360	993-193-11360	993-293-11360	993-393-11360
380	993-193-11380	993-293-11380	993-393-11380
400	993-193-11400	993-293-11400	993-393-11400
420	993-193-11420	993-293-11420	993-393-11420
440	993-193-11440	993-293-11440	993-393-11440
460	993-193-11460	993-293-11460	993-393-11460
480	993-193-11480	993-293-11480	993-393-11480



BLF - Biotech Long Anterograd / Retrograd Femoral Nail

d= 8mm			
L mm	ANODISED TITAN	TITAN	STEEL
280	994-194-08280	994-294-08280	994-394-08280
300	994-194-08300	994-294-08300	994-394-08300
320	994-194-08320	994-294-08320	994-394-08320
340	994-194-08340	994-294-08340	994-394-08340
360	994-194-08360	994-294-08360	994-394-08360
380	994-194-08380	994-294-08380	994-394-08380
400	994-194-08400	994-294-08400	994-394-08400
420	994-194-08420	994-294-08420	994-394-08420
440	994-194-08440	994-294-08440	994-394-08440
460	994-194-08460	994-294-08460	994-394-08460
480	994-194-08480	994-294-08480	994-394-08480

d= 9mm			
L mm	ANODISED TITAN	TITAN	STEEL
300	994-194-09300	994-294-09300	994-394-09300
320	994-194-09320	994-294-09320	994-394-09320
340	994-194-09340	994-294-09340	994-394-09340
360	994-194-09360	994-294-09360	994-394-09360
380	994-194-09380	994-294-09380	994-394-09380
400	994-194-09400	994-294-09400	994-394-09400
420	994-194-09420	994-294-09420	994-394-09420
440	994-194-09440	994-294-09440	994-394-09440
460	994-194-09460	994-294-09460	994-394-09460
480	994-194-09480	994-294-09480	994-394-09480

d= 10mm			
L mm	ANODISED TITAN	TITAN	STEEL
300	994-194-10300	994-294-10300	994-394-10300
320	994-194-10320	994-294-10320	994-394-10320
340	994-194-10340	994-294-10340	994-394-10340
360	994-194-10360	994-294-10360	994-394-10360
380	994-194-10380	994-294-10380	994-394-10380
400	994-194-10400	994-294-10400	994-394-10400
420	994-194-10420	994-294-10420	994-394-10420
440	994-194-10440	994-294-10440	994-394-10440
460	994-194-10460	994-294-10460	994-394-10460
480	994-194-10480	994-294-10480	994-394-10480

d= 11mm			
L mm	ANODISED TITAN	TITAN	STEEL
300	994-194-11300	994-294-11300	994-394-11300
320	994-194-11320	994-294-11320	994-394-11320
340	994-194-11340	994-294-11340	994-394-11340
360	994-194-11360	994-294-11360	994-394-11360
380	994-194-11380	994-294-11380	994-394-11380
400	994-194-11400	994-294-11400	994-394-11400
420	994-194-11420	994-294-11420	994-394-11420
440	994-194-11440	994-294-11440	994-394-11440
460	994-194-11460	994-294-11460	994-394-11460
480	994-194-11480	994-294-11480	994-394-11480
500	994-194-11500	994-294-11500	994-394-11500

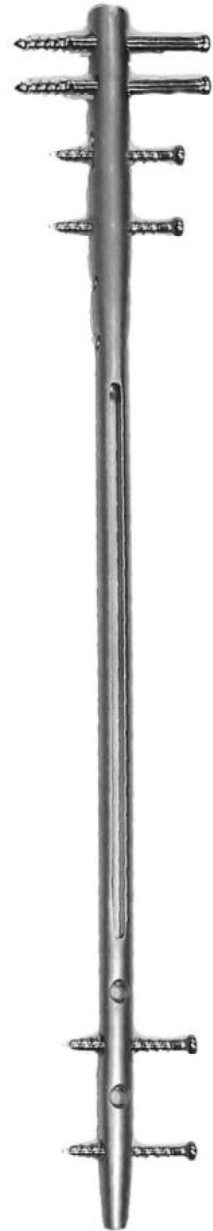

BLF - Biotech Long Anterograd / Retrograd Femoral Nail

d= 12mm			
L mm	ANODISED TITAN	TITAN	STEEL
300	994-194-12300	994-294-12300	994-394-12300
320	994-194-12320	994-294-12320	994-394-12320
340	994-194-12340	994-294-12340	994-394-12340
360	994-194-12360	994-294-12360	994-394-12360
380	994-194-12380	994-294-12380	994-394-12380
400	994-194-12400	994-294-12400	994-394-12400
420	994-194-12420	994-294-12420	994-394-12420
440	994-194-12440	994-294-12440	994-394-12440
460	994-194-12460	994-294-12460	994-394-12460
480	994-194-12480	994-294-12480	994-394-12480
500	994-194-12500	994-294-12500	994-394-12500

d= 13mm			
L mm	ANODISED TITAN	TITAN	STEEL
300	994-194-13300	994-294-13300	994-394-13300
320	994-194-13320	994-294-13320	994-394-13320
340	994-194-13340	994-294-13340	994-394-13340
360	994-194-13360	994-294-13360	994-394-13360
380	994-194-13380	994-294-13380	994-394-13380
400	994-194-13400	994-294-13400	994-394-13400
420	994-194-13420	994-294-13420	994-394-13420
440	994-194-13440	994-294-13440	994-394-13440
460	994-194-13460	994-294-13460	994-394-13460
480	994-194-13480	994-294-13480	994-394-13480
500	994-194-13500	994-294-13500	994-394-13500

d= 14mm			
L mm	ANODISED TITAN	TITAN	STEEL
300	994-194-14300	994-294-14300	994-394-14300
320	994-194-14320	994-294-14320	994-394-14320
340	994-194-14340	994-294-14340	994-394-14340
360	994-194-14360	994-294-14360	994-394-14360
380	994-194-14380	994-294-14380	994-394-14380
400	994-194-14400	994-294-14400	994-394-14400
420	994-194-14420	994-294-14420	994-394-14420
440	994-194-14440	994-294-14440	994-394-14440
460	994-194-14460	994-294-14460	994-394-14460
480	994-194-14480	994-294-14480	994-394-14480
500	994-194-14500	994-294-14500	994-394-14500

d= 15mm			
L mm	ANODISED TITAN	TITAN	STEEL
300	994-194-15300	994-294-15300	994-394-15300
320	994-194-15320	994-294-15320	994-394-15320
340	994-194-15340	994-294-15340	994-394-15340
360	994-194-15360	994-294-15360	994-394-15360
380	994-194-15380	994-294-15380	994-394-15380
400	994-194-15400	994-294-15400	994-394-15400
420	994-194-15420	994-294-15420	994-394-15420
440	994-194-15440	994-294-15440	994-394-15440
460	994-194-15460	994-294-15460	994-394-15460
480	994-194-15480	994-294-15480	994-394-15480
500	994-194-15500	994-294-15500	994-394-15500

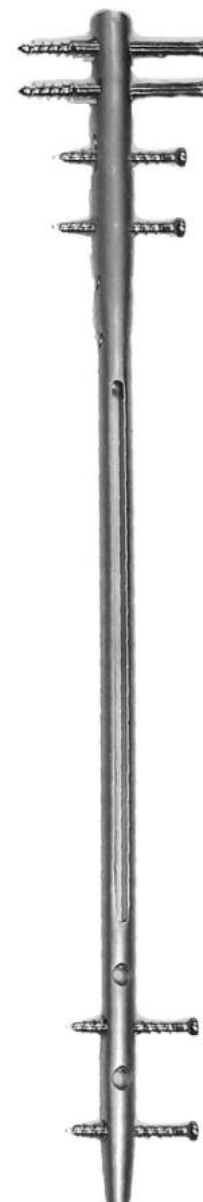

BSF Nail - Biotech Short Anterograd / Retrograd Femoral nail

d= 8 mm			
L mm	ANODISED TITAN	TITAN	STEEL
220	996-196-08220	996-296-08220	996-396-08220
240	996-196-08240	996-296-08240	996-396-08240
260	996-196-08260	996-296-08260	996-396-08260

d= 9mm			
L mm	ANODISED TITAN	TITAN	STEEL
220	996-196-09220	996-296-09220	996-396-09220
240	996-196-09240	996-296-09240	996-396-09240
260	996-196-09260	996-296-09260	996-396-09260

d= 10mm			
L mm	ANODISED TITAN	TITAN	STEEL
220	996-196-10220	996-296-10220	996-396-10220
240	996-196-10240	996-296-10240	996-396-10240
260	996-196-10260	996-296-10260	996-396-10260

d= 11mm			
L mm	ANODISED TITAN	TITAN	STEEL
220	996-196-11220	996-296-11220	996-396-11220
240	996-196-11240	996-296-11240	996-396-11240
260	996-196-11260	996-296-11260	996-396-11260

d= 12mm			
L mm	ANODISED TITAN	TITAN	STEEL
220	996-196-12220	996-296-12220	996-396-12220
240	996-196-12240	996-296-12240	996-396-12240
260	996-196-12260	996-296-12260	996-396-12260

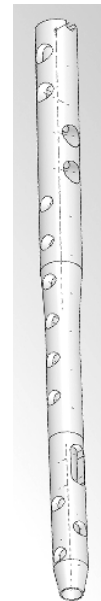

BSP - Biotech Short Petrochanter nail

BLP - Biotech Long Petrochanter nail

d= 10mm

L mm	ANODISED TITAN	TITAN	STEEL
220	960-160-10220	960-260-10220	960-360-10220
240	960-160-10240	960-260-10240	960-360-10240
260	960-160-10260	960-260-10260	960-360-10260

d= 11mm

L mm	ANODISED TITAN	TITAN	STEEL
220	960-160-11220	960-260-11220	960-360-11220
240	960-160-11240	960-260-11240	960-360-11240
260	960-160-11260	960-260-11260	960-360-11260

d= 12 mm left

L mm	ANODISED TITAN	TITAN	STEEL
340	967-167-12340	967-267-12340	967-367-12340
360	967-167-12360	967-267-12360	967-367-12360
380	967-167-12380	967-267-12380	967-367-12380
400	967-167-12400	967-267-12400	967-367-12400
420	967-167-12420	967-267-12420	967-367-12420

d= 12 mm right

L mm	ANODISED TITAN	TITAN	STEEL
340	966-166-12340	966-266-12340	966-366-12340
360	966-166-12360	966-266-12360	966-366-12360
380	966-166-12380	966-266-12380	966-366-12380
400	966-166-12400	966-266-12400	966-366-12400
420	966-166-12420	966-266-12420	966-366-12420



Nail closing plug

ANODISED TITAN	TITAN	STEEL
987-187-00008	987-287-00008	987-387-00008



Elastic Nails

SIZE	STEEL
DIAM. 1,5 mm / lenght: 150mm	962-362-15150
DIAM. 1,5 mm / lenght: 400mm	962-362-15400
DIAM. 2,0 mm / lenght: 200mm	962-362-20200
DIAM. 2,0 mm / lenght: 400mm	962-362-20400
DIAM. 2,5 mm / lenght: 250mm	962-362-25250
DIAM. 2,5 mm / lenght: 400mm	962-362-25400
DIAM. 3,0 mm / lenght: 300mm	962-362-30300
DIAM. 3,0 mm / lenght: 400mm	962-362-30400
DIAM. 3,5 mm / lenght: 350mm	962-362-35350
DIAM. 3,5 mm / lenght: 400mm	962-362-35400

SIZE	TITAN
1,5mm x 440 mm	951-251-15440
2,5mm x 440 mm	951-251-25440
3,5mm x 440 mm	951-251-25440
4,5mm x 440 mm	951-251-45440
1,5mm x 400 mm	951-251-15400
2,0mm x 400 mm	951-251-20400
2,5mm x 400 mm	951-251-25400
3,0mm x 400 mm	951-251-30400
3,5mm x 400 mm	951-251-35400
4,0mm x 400 mm	951-251-40400
4,5mm x 400 mm	951-251-45400



Rush Nail

D mm	L mm	cat.no.
3,2	100	981-381-32100
3,2	115	981-381-32115
3,2	130	981-381-32130
3,2	145	981-381-32145
3,2	160	981-381-32160
3,2	175	981-381-32175
3,2	190	981-381-32190
3,2	205	981-381-32205
3,2	220	981-381-32220
3,2	235	981-381-32235
3,2	250	981-381-32250
3,2	265	981-381-32265
3,2	280	981-381-32280
4,8	180	981-381-48180
4,8	200	981-381-48200
4,8	220	981-381-48220
4,8	240	981-381-48240
4,8	260	981-381-48260
4,8	280	981-381-48280
4,8	300	981-381-48300
4,8	320	981-381-48320
4,8	340	981-381-48340





BIOTECH

Intra-medullary Nailing instrument sets

1. Biotech Humeral Nailing instrument set
2. Biotech Tibial Nailing instrument set
3. BLF - Biotech Long A/R Femoral Nailing instrument set
4. BSP - Biotech Short Pertrochanter Nailing instrument set

 BIOTECH	Biotech Humeral Nailing instrument set 679-0017-1108	
---	---	--

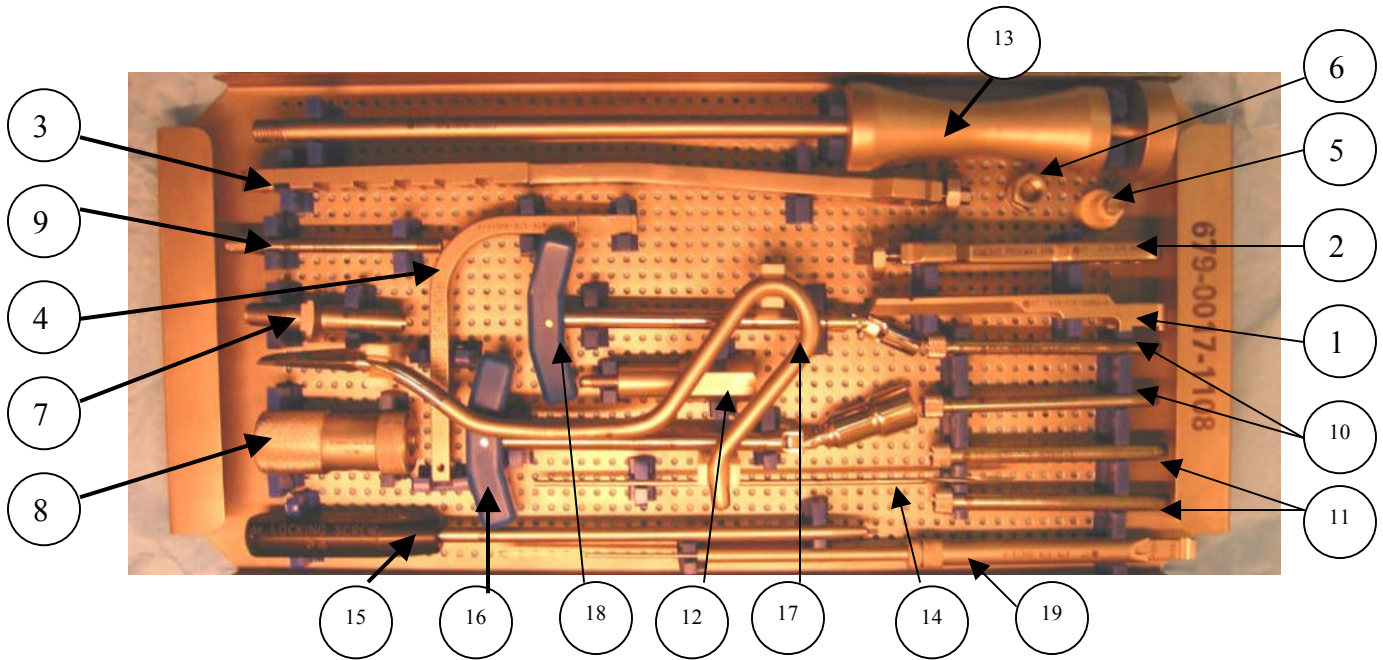

	Biotech code	description	pcs/set
1	679-579-00000H	basis target arm	1
2	679-579-80001	proximal humeral target arm	1
3	679-579-80011	distal humeral target arm	1
4	679-579-80011-1	distal humeral target arm - "L"-arm	1
5	679-579-80011-2	fixation screw (for distal arm)	1
6	679-579-10006	nut (for driver bushing)	1
7	679-579-10002H	driver bushing	1
8	679-579-10005H	driver handle	1
9	679-579-10003H	driver bolt	1
10	679-579-80001-3	drill bushing	2
11	679-579-80001-4	guide tube	2
12	679-579-00013	extractor adapter	1
13	679-579-00014	hammer extractor	1
14	694-394-32250	drill dia. 3,2x250 mm	1
15	699-399-04525	screwdriver 2,5 mm	1
16	699-399-99080	wrench 10 mm	1
17	699-399-99012	awl	1
18	699-399-99079	wrench	1
19	679-579-00015H	screw depth gauge	1



BIOTECH

**Biotech Tibia Nailing
instrument set
679-0017-1101-1**

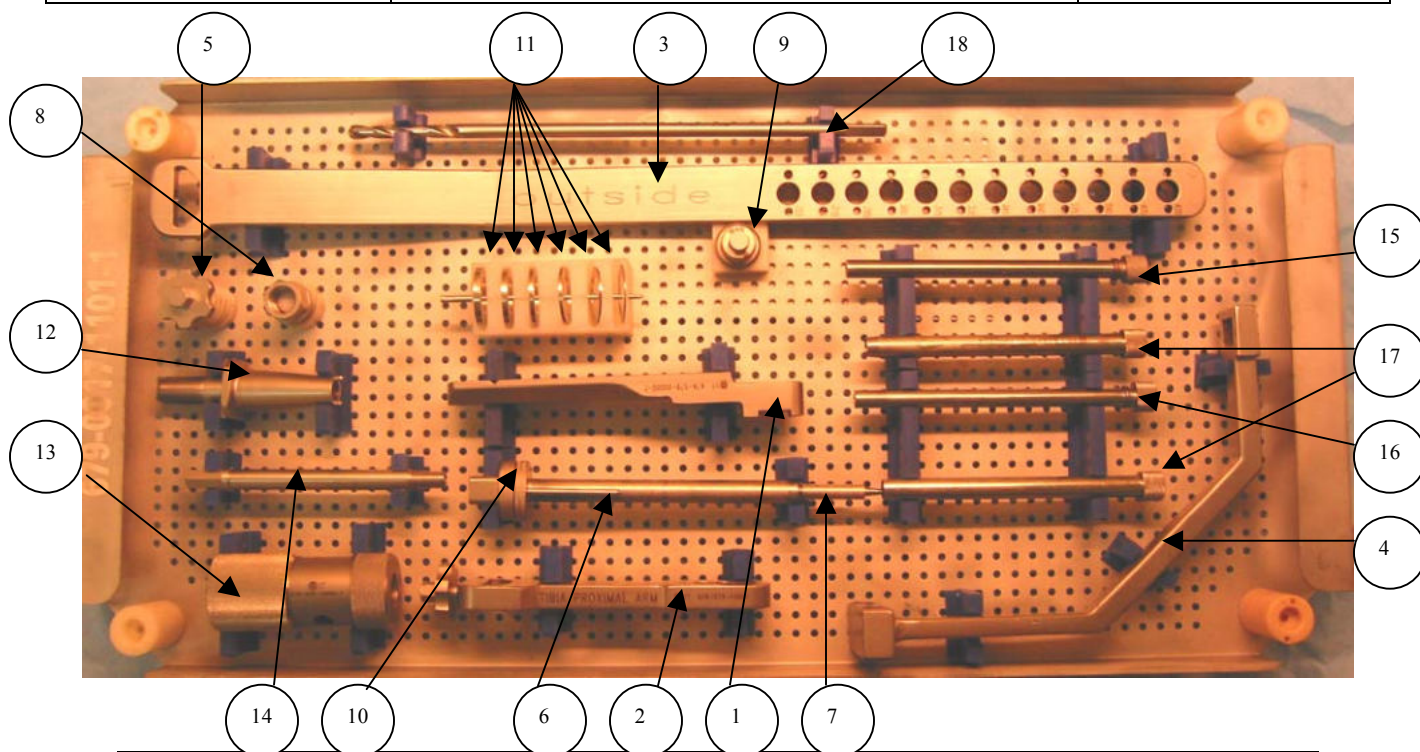

	Biotech code	description	pcs/set
1	679-579-00000T	basis target arm	1
2	679-579-10001	proximal tibia target arm	1
3	679-579-10011	distal tibia target arm	1
4	679-579-10011-1	distal tibia arm - "L"-arm	1
5	679-579-10011-2	fixation screw (for distal arm)	1
6	679-579-50011-3	orientation guide tube for distal aiming	1
7	679-579-50011-4	orientation rod for distal aiming	1
8	679-579-10006	nut (for driver bushing)	1
9	679-579-10009	fixation nut (for distal targeting arm)	1
10	679-579-10002	fixation screw for distal orientation	1
11	679-579-10010 - 15	spacer nut #1 – 6#	1
12	679-579-10002T	driver bushing	1
13	679-579-10005T	driver handle	1
14	679-579-10003T	driver bolt	1
15	679-579-10001-3	drill bushing 4,5/135,5	1
16	679-579-10001-5	drill bushing 3,5/135,5	1
17	679-579-10001-4	guide tube 9,5mm	2
18	694-394-65235	Drill 6,5mm x 235mm	1



BIOTECH

**Biotech Tibia Nailing
instrument set
679-0017-1101-2**

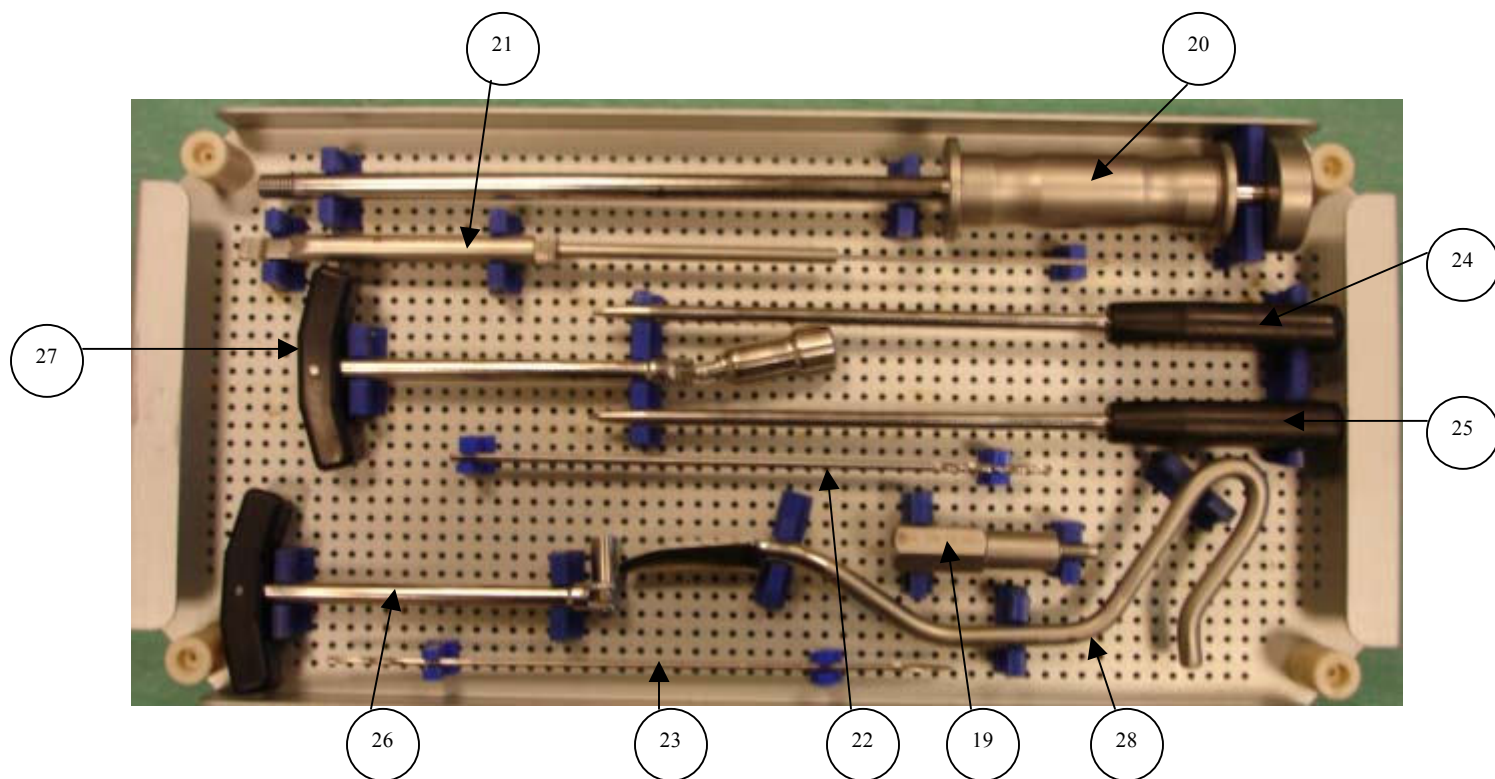

	Biotech code	description	pcs/set
19	679-579-00013	extractor adapter	1
20	679-579-00014	hammer extractor	1
21	679-579-00015T	screw depth gauge	1
22	694-394-42250	drill dia.4,2x250 mm	2
23	694-394-32250	drill dia.3,2x250 mm	2
24	699-399-04525	screwdriver 2,5 mm	1
25	699-399-04535	screwdriver 3,5 mm	1
26	699-399-99079	wrench 10 mm	1
27	699-399-99080	wrench 16 mm	1
28	699-399-99012	awl	1



BIOTECH

**BLF-Biotech Long Femoral
Nailing instrument set
679-0017-1105-1**

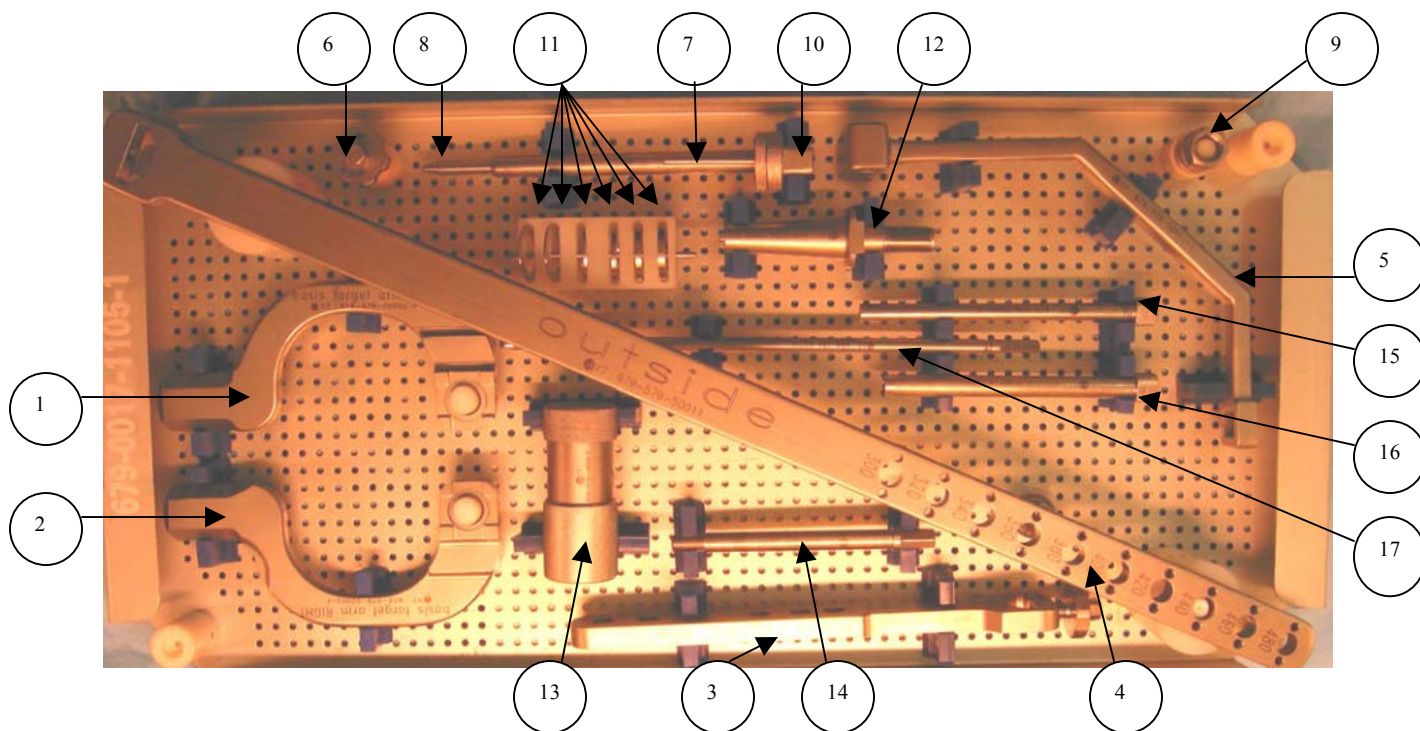

	Biotech code	description	pcs/set
1	679-579-00001F	basis target arm, left	1
2	679-579-00002F	basis target arm, right	1
3	679-579-50001	proximal femur target arm	1
4	679-579-50011	distal femur target arm	1
5	679-579-50011-1	distal femur target arm - "L"-arm	1
6	679-579-10007	fixation screw (for distal arm)	1
7	679-579-50011-3	orientation guide tube for distal aiming	1
8	679-579-50011-4	orientation rod for distal aiming	1
9	679-579-10006	nut (for driver bushing)	1
10	679-579-10009	fixation screw for distal orientation	1
11	679-579-10010 - 15	spacer nut #1 – spacer nut #6	1
12	679-579-10002F	driver bushing	1
13	679-579-10005F	driver handle	1
14	679-579-10003F	driver bolt	1
15	679-579-50001-3	drill bushing	2
16	679-579-50001-4	guide tube	2
17	694-394-65235	Drill 6,5mm x 235mm	2



BIOTECH

**BLF-Biotech Long Femoral
Nailing instrument set
679-0017-1105-2**

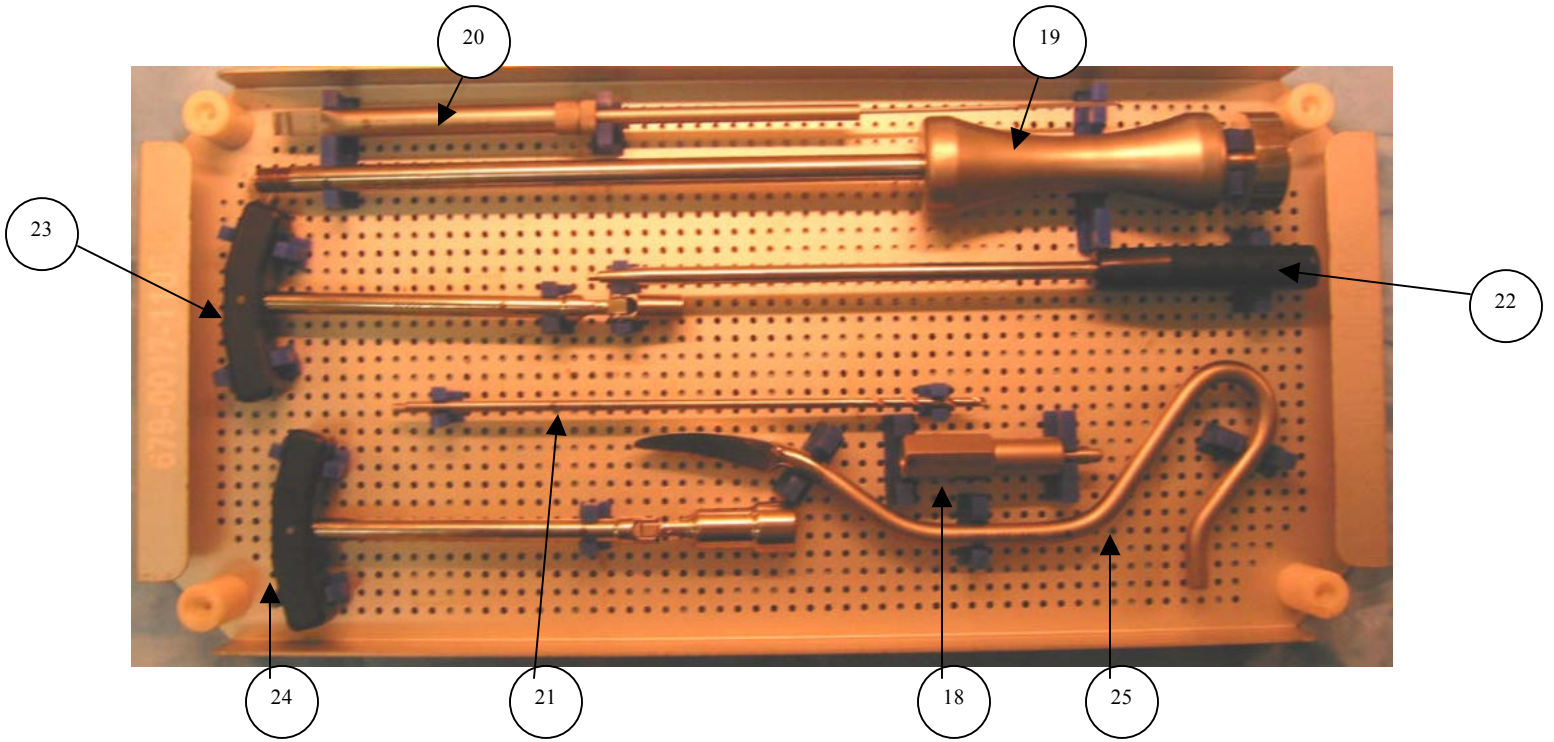

	Biotech code	description	pcs/set
18	679-579-00013	extractor adapter	1
19	679-579-00014	hammer extractor	1
20	679-579-00015F	screw depth gauge	1
21	694-394-42250	drill dia.4,2x250 mm	1
22	699-399-04535	screwdriver 3,5 mm	1
23	699-399-99079	wrench	1
24	699-399-99080	wrench 16 mm	1
25	699-399-99012	awl	1

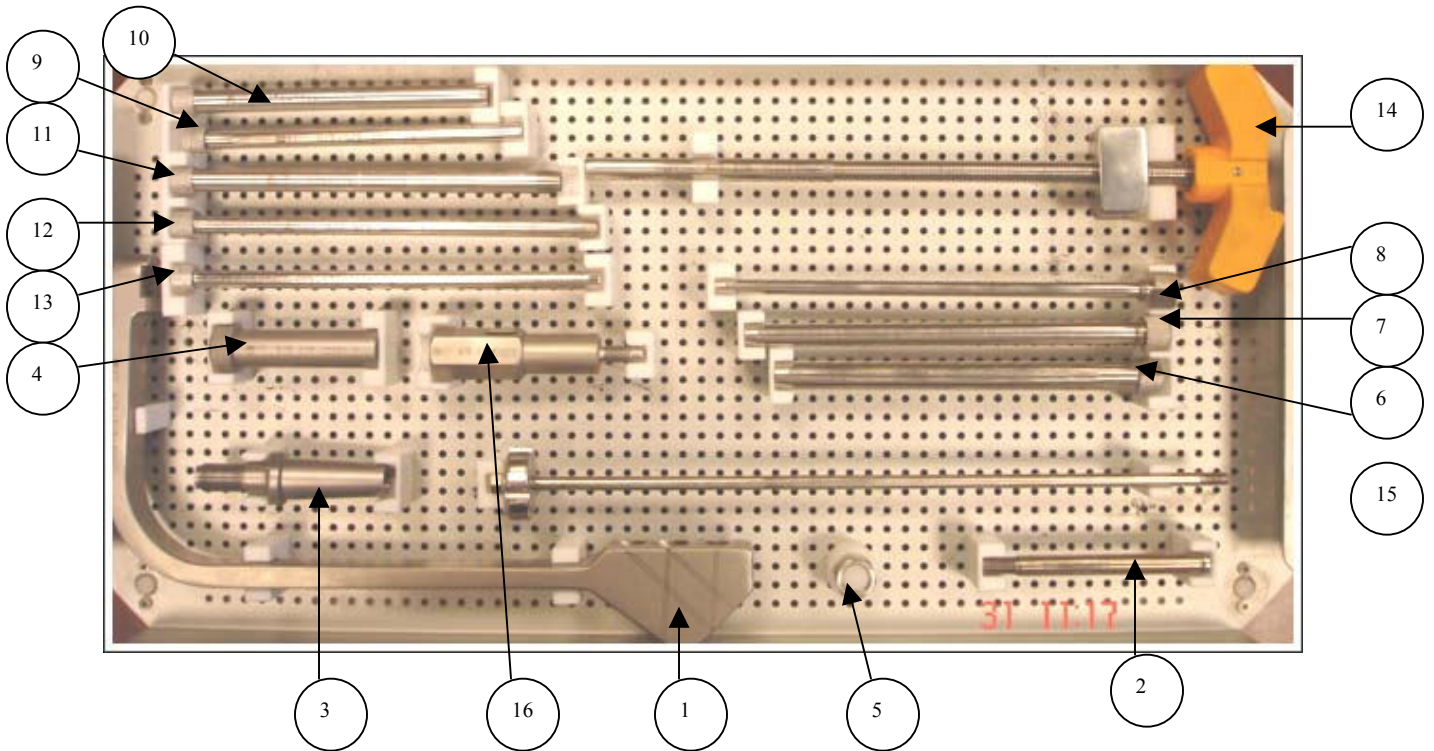

	Biotech code	Description	Pcs./set
1	679-579-40001	perthrochanter targeting arm	1
2	679-579-10003-P	driver bolt	1
3	679-579-10002-P	driver bushing	1
4	679-579-10001-P	driver handle	1
5	679-579-10004	Fixation nut for driver bushing	1
6	679-579-40001-2	guide tube Ø12/10,4	1
7	679-579-40001-1	drill guide Ø10,1/7,2	1
8	679-579-40001-3	wire guide Ø7/2,5	1
9	679-579-40001-4	drill guide Ø7,9/4,5	1
10	679-579-40001-5	guide tube Ø10/8,1	1
11	679-579-40001-6	guide tube Ø10	1
12	679-579-40001-7	drill guide Ø4,5	1
13	679-579-40001-8	wire guide	1
14	679-579-40003	compression T-wrench	1
15	679-579-40003-1	screw fixation for compression T-wrench	1
16	679-579-00013	extractor adapter	1

	<p align="center">BSP-Biotech Short Petrochanter Nailing instrument set 679-0017-0104-2</p>	
---	--	--

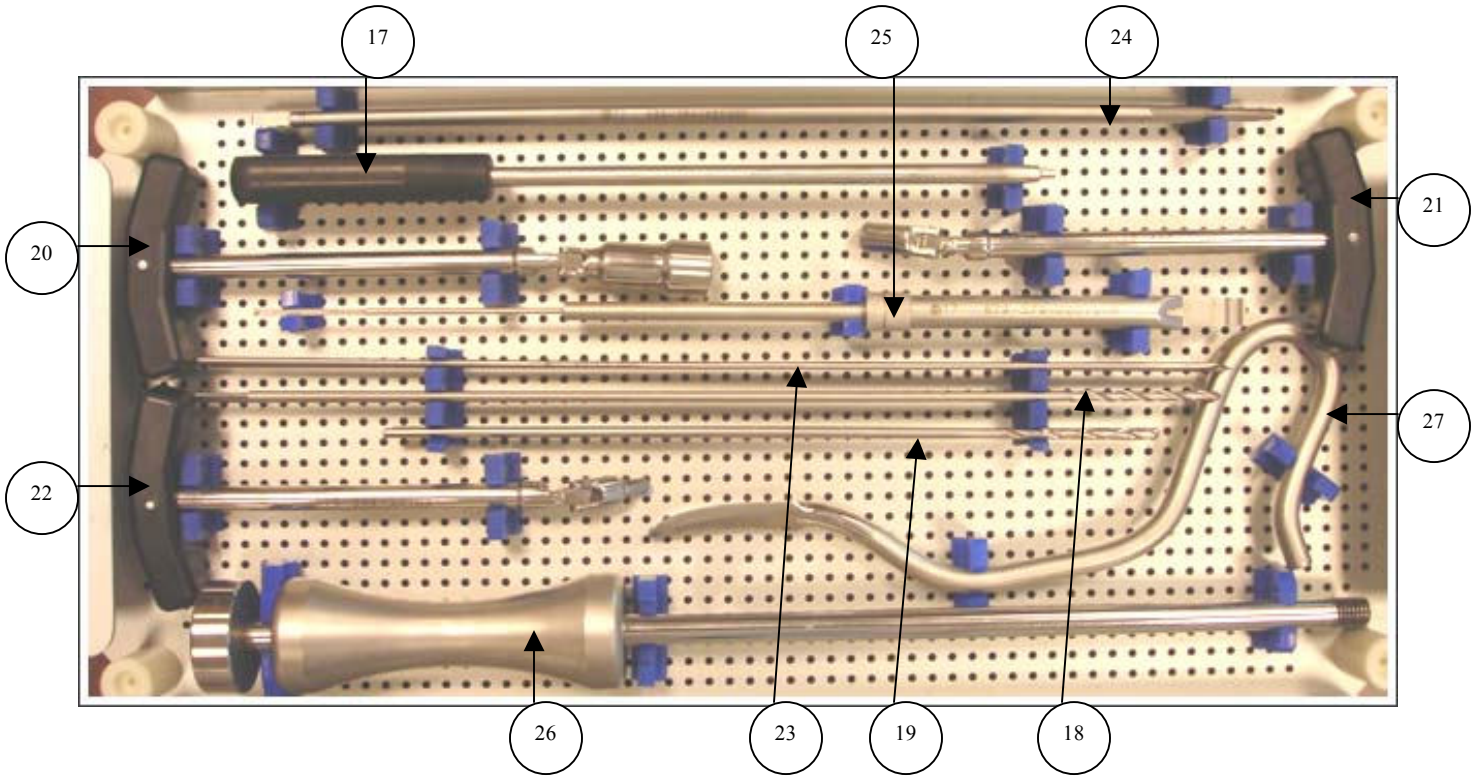

	Biotech code	Description	Pcs./set
17	699-399-04535	screw driver 3,5mm	1
18	694-394-42300	4,2x300 spiral drill	2
19	694-394-42400	4,2x400 spiral drill	2
20	699-399-99101	Wrench 16	1
21	699-399-99102	Wrench 8	1
22	699-399-99103	Wrench 6	1
23	679-579-30400	Wire 3x400	3
24	694-394-651400	6,5/5,2x400 stepped reamer	2
25	679-579-00015P	screw depth gauge	1
26	679-579-00014	hammer extractor	1
27	699-399-99012	awl	1



BIOTECH

External Fixation

1. External Fixation with tubes
2. Dynamic external fixation

EXTERNAL FIXATION WITH TUBES

ART.NR.	DESCR./SIZE
963-363-11100	TUBE diam. 11 mm, lenght: 100
963-363-11125	TUBE diam. 11 mm, lenght: 125
963-363-11150	TUBE diam. 11 mm, lenght: 150
963-363-11200	TUBE diam. 11 mm, lenght: 200
963-363-11250	TUBE diam. 11 mm, lenght: 250
963-363-11300	TUBE diam. 11 mm, lenght: 300
963-363-11350	TUBE diam. 11 mm, lenght: 350
963-363-11400	TUBE diam. 11 mm, lenght: 400
963-363-11450	TUBE diam. 11 mm, lenght: 450
963-363-11500	TUBE diam. 11 mm, lenght: 500
963-363-11550	TUBE diam. 11 mm, lenght: 550
963-363-11600	TUBE diam. 11 mm, lenght: 600
963-363-00001	single coupling
963-363-00002	double coupling



DYNAMIC EXTERNAL FIXATION

Dynamic External Fixation for Tibia and Femur

CAT. NO	SIZE
952-352-21000	small
952-352-21001	standard
952-352-21002	large

Dynamic External Fixation for Humerus

CAT. NO	SIZE
952-352-31001	standard
952-352-31002	large

BIOTECH

“Movement is Life”

Biotech GmbH
 Hauptstraße 113.
 56598 Rheinbrohl Germany
 Tel : +49 2635 92221-0
 Email : office-de@biotech-medical.net
 www.biotech-medical.com

REF:
VB-006-PROSP-PC

Revision
2

Publication date :
01.04.2022.

